

---

# *PBFT VS SPC User Guide*

Version 20.2  
December 9, 2021  
CE Compliant  
Part No. PBT-002P

*for use with:*

FORCEWare™ software, version 5.7.0

*on:*

Peel Back Force Tester - PN PBFTVS.USB700



prepared by GPD Global® Documentation Department

**GPD Global**®

611 Hollingsworth Street  
Grand Junction, CO, USA 81505  
tel: +1.970.245-0408 • fax +1.970.245-9674  
request@gpd-global.com • www.gpd-global.com

Copyright © 2021 GPD Global® • All Rights Reserved

---

# Front matter

---

## Revision notes

Date	Version	Notes
12/09/2021	20.2	<p data-bbox="980 447 1032 470"><b>New</b></p> <ul data-bbox="586 478 846 501" style="list-style-type: none"><li data-bbox="586 478 846 501">• Release notes: added.</li></ul> <p data-bbox="922 506 1089 529"><b>Improvements</b></p> <ul data-bbox="586 537 1403 709" style="list-style-type: none"><li data-bbox="586 537 1403 590">• Specifications &gt; Strain Gauge: clarified that the 250 gram strain gauge is an option, not a model of PBFT.</li><li data-bbox="586 594 1170 617">• References: updated mechanical assembly drawings.</li><li data-bbox="586 621 1403 674">• References: renamed PBFT-3D5 mechanical assembly drawing to PBFTVS.USB700. Deleted mechanical assembly drawing PBFT-3D5 250G.</li><li data-bbox="586 678 1019 701">• Headings: updated to "Sentence case".</li></ul> <p data-bbox="976 709 1040 732"><b>Fixes</b></p> <ul data-bbox="586 741 1419 793" style="list-style-type: none"><li data-bbox="586 741 1419 793">• Specifications &gt; Weight Declaration: added "20" to weights listed for standard strain gauge.</li></ul>

## Table of contents

### Front matter - ii

Revision notes .....	ii
Table of contents .....	iii
Safety notices .....	vii
Trademarks .....	x
Warranty .....	xi

### Getting started - 1

#### Introduction - 2

Function .....	2
Theory of operation .....	2
Mechanical controls .....	3
Software controls .....	4

#### Installation - 5

Installation summary .....	5
Installation procedure .....	5
1. Unpack & assemble .....	5
2. Verify mechanical operations .....	6
3. Download software & documentation .....	6
4. Install & configure interface card software .....	7
5. Install FORCEWare SPC software .....	11
6. Initial start up .....	12

#### Configure & verify calibration - 14

Configure & verify calibration summary .....	14
Configure & verify calibration procedure .....	15
1 - Configure PBFT with computer .....	15
2 - Verify PBFT speed .....	15
3 - Verify PBFT strain gauge .....	18

#### Basic operations - 20

Basic operations summary .....	20
Basic operations procedure .....	21
1 - Start up .....	21
2 - Verify speed .....	22
3 - Configure printer .....	23
4 - Open PBFT control center .....	26
5 - Modify test parameters .....	27
6 - Load carrier tape .....	28
7 - Run a test .....	30
8 - Additional operations .....	32
9 - Shutdown .....	41

#### Advanced operations - 42



Presets .....	43
SPC analysis tools .....	44

Report & label samples .....	46
User access .....	49
Disabling live update .....	53
Language selection .....	54
<b>Window references - 56</b>	
About FORCEWare .....	57
Account Manager - Access .....	58
Account Manager - Accounts .....	60
Account Manager - Data .....	61
Account Manager - Print .....	63
Account Manager - RS232 .....	65
Advanced Printer Configuration .....	66
Calibrate Speed .....	68
Calibrate Strain Gauge .....	69
Create Preset - Data .....	70
Create Preset - Presets .....	72
Create Preset - Print .....	73
Data Storage .....	75
GPD FORCEWare .....	76
Login .....	77
PBFT Control Center .....	78
Period Selection .....	80
Printer Configuration .....	81
SPC Analysis .....	82
Test Parameter Options .....	84
Test Results .....	85
Unit of Force .....	86
User Defined Fields .....	87
<b>Maintenance - 88</b>	
Preventive maintenance schedule .....	88
Replace lamp .....	89
Calibration accuracy .....	89
<b>Troubleshooting - 96</b>	
Uninstall FORCEWare software .....	98
<b>Spare parts &amp; accessories - 99</b>	
<b>Specifications - 100</b>	
<b>References - 102</b>	
Drawings .....	102
Diagram .....	102
Schematics .....	102

## Safety notices

**IMPORTANT** For your personal protection, read all instructions before operating this machine.

## Warning notices





-  **WARNING:** No operator replaceable fuses are included. (Fuses are located at the IEC power inlet.) Contact manufacturer for replacement fuses; use of a fuse other than original equipment may cause fire or loss of system and injury to personnel.
-  **WARNING:** Weight of system is approximately 66 pounds (30 Kg) and requires two persons lifting or use of a lifting aid. Failure to follow these instructions may result in injury to persons and damage to the system and other equipment.
-  **WARNING:** This equipment must be used in the manner indicated in these instructions. Use for any other purpose may cause damage to the equipment, injury, or loss.

## Caution notices

-  **CAUTION - PINCH POINTS:** Keep hands away from drive and motor. Drive and motor are located inside the enclosure and include a drive chain. Contact with these parts may result in injury or loss of finger(s). Shut down system by disconnecting the power cord and locking the cord out before opening enclosure.

A pinch point label, on removable cover and/or inside next to chain drive is provided similar to the label shown here:





-  **CAUTION:** The end user shall inspect the equipment and note any damage or defects; the system should not be used if damaged or defective. The power cord must be in perfect condition, any damage to the power cord, or connections and the cord, should be destroyed and replaced before use of the equipment.
-  **CAUTION:** Types of Electrical Work — Only Type 1 — Equipment is fully de-energized, electrical work is permitted.
-  **CAUTION:** Fire hazards exist; thermal and non-thermal damage is possible outside the equipment.
-  **CAUTION - SHIPPING:** The system is stable under most shipping and handling conditions; it is protected in shipping box.
-  **CAUTION - SEISMIC:** The system is table mounted, or shelf mounted. The system should be bolted to the table or shelf for seismic restraint per the requirements of the manufacturers. Contact for details if required. The table should be restrained by bolting to the floor per the manufacturers specifications.

 **CAUTION - TABLE MOUNTING:** The table should be rated for this load and should be stable and rated for at least 300 pounds load.

## Strain Gauge

 **CAUTION: STRAIN GAUGE - BATTERY PACK** DO NOT use other types of chargers besides the PBFT built-in battery charger. The strain gauge is equipped with a rechargeable NiMH (Nickel Metal Hydride) battery pack which is not accessible to the operator and should only be replaced by qualified maintenance or technical personnel fully aware of all safety precautions.

 **CAUTION: STRAIN GAUGE - SPEED** DO NOT strike or jar the strain gauge. Apply pressure to the strain gauge clip in a pulling or pushing motion, not by hitting or jarring it. Applying force to this precision instrument at an excessive speed may result in permanent damage to the unit.

 **CAUTION: STRAIN GAUGE - FORCE** DO NOT apply force to the strain gauge beyond recommended limit of 1 kg for standard strain gauge or 0.25 kg for 250g strain gauge. Applying excessive weight to this clip, which measures the peel back force of the cover tape, may result in permanent damage to the unit.

## Important notices

**IMPORTANT:** For use in the EU an EU CE marked cord set should be utilized; this would be CE marked by supplier. Cord should be not more than 2 meters in length and not less than 15 amps rating. The cord must include a ground lug and ground wire of not less than 5 amperes rating.

**POWER SOURCE** Operate the PBFT only from the type of power source indicated on the data plate.

**GROUNDING** The PBFT is equipped with a 3-wire grounding type plug (a plug with a third grounding pin). The 3-wire grounding type plug will fit into a grounding type power outlet. This is a safety feature. If you are unable to insert the plug into the outlet, contact your electrician to replace your obsolete outlet. Do not defeat the safety purpose of the grounding plug.

**WATER & MOISTURE** DO NOT use the PBFT near water or moisture (damp or wet floor, bench, or table) as corrosion can affect the smooth, consistent operation of the carriage, and thereby the PBFT readings.

**ATTACHMENTS** DO NOT use attachments not recommended by GPD Global with the PBFT.

## Hazardous Energy Control

---

**IMPORTANT:** The system must be locked out/tagged out before opening: power system down, turn off at switch at main power inlet. Remove power cord from wall socket, remove power cord from system, install lock and tag on power cord and power inlet, if required. Test if system starts by pressing start buttons.

To restore use of systems: make sure all tools are removed and cover is reinstalled with all crews in place. Remove lock and tag after informing all in area of actions. If a screw is missing, request replacements from the manufacturer. Re-install cord to the power inlet; be sure this is the correct cord before use and be sure cord is free from all damage. Once cord is installed, check that power switch is off and all persons are clear of the system. Plug cord into facilities power wall outlet. Turn on system. Verify that no damage is occurring and that no failure has happened. Restart system.

## EMO Emergency Machine Off

---

**IMPORTANT:** To shut down the system in an emergency unplug system from wall outlet.

### Attention notices

- **ATTENTION:** Items that become solid waste as a result of the operation, maintenance, and servicing of the equipment, and that are constructed of or contain substances whose disposal might be regulated (e.g., beryllium containing parts, vapor lamps, mercury switches, batteries, contaminated parts, maintenance wastes), include test samples, grease, wipes, fuses, batteries.
- **ATTENTION:** When decommissioning the System, contact the manufacturer for advice. The system, once decontaminated, is made from a range of low hazard materials, including: aluminum, steel, brass, glass, and various synthetic materials.

It is recommended that printed circuit boards are disposed of via a specialist salvage agency. The remaining structure may be broken down and sorted by material. Most of the materials are metallic and are recyclable. Specialist agencies will be able to advise on the suitability of recycling synthetics.

Legislation may differ between countries, states and regions; therefore, you should seek advice from local environmental / health and safety organizations to ensure that arrangements for disposal are acceptable under local regulations.

## Trademarks

GPD Global is a registered trade-mark of GPD Global, Inc.

FORCEWare is a trade-mark of GPD Global, Inc.

InstaCal is copyrighted by Measurement Computing.

Windows is registered trademark of Microsoft Corporation in the United States and/or other countries.

Throughout this manual, trademarks are used. Rather than put a trademark symbol in every occurrence of a trademarked name, we state that we are using the names in an editorial fashion only and to the benefit of the trademark owner with no intention of infringement of the trademark.



## Warranty

**General Warranty.** Subject to the remedy limitation and procedures set forth in the Section “Warranty Procedures and Remedy Limitations,” GPD Global warrants that the system will conform to the written description and specifications furnished to Buyer in GPD Global’s proposal and specified in the Buyer’s purchase order, and that it will be free from defects in materials and workmanship for a period of one (1) year. GPD Global will repair, or, at its option, replace any part which proves defective in the sole judgment of GPD Global within one (1) year of date of shipment/invoice. Separate manufacturers’ warranties may apply to components or subassemblies purchased from others and incorporated into the system. THIS WARRANTY IS EXPRESSLY IN LIEU OF ANY AND ALL OTHER WARRANTIES, EXPRESS OR IMPLIED, INCLUDING WARRANTIES OF MERCHANTABILITY OR FITNESS FOR A PARTICULAR PURPOSE.

**Limitations.** GPD Global reserves the right to refuse warranty replacement, where, in the sole opinion of GPD Global the defect is due to the use of incompatible materials or other damages from the result of improper use or neglect.

This warranty does not apply if the GPD Global product has been damaged by accident, abuse, or has been modified without the written permission of GPD Global.

Items considered replaceable or rendered unusable under normal wear and tear are not covered under the terms of this warranty. Such items include fuses, lights, filters, belts, etc.

**Warranty Procedures and Remedy Limitations.** The sole and exclusive remedy of the buyer in the event that the system or any components of the system do not conform to the express warranties stated in the Section “Warranties” shall be the replacement of the component or part. If on-site labor of GPD Global personnel is required to replace the non-warranted defective component, GPD Global reserves the right to invoice the Buyer for component cost, personnel compensation, travel expenses and all subsistence costs. GPD Global’s liability for a software error will be limited to the cost of correcting the software error and the replacement of any system components damaged as a result of the software error. In no event and under no circumstances shall GPD Global be liable for any incidental or consequential damages; its liability is limited to the cost of the defective part or parts, regardless of the legal theory of any such claim. As to any part claimed to be defective within one (1) year of date of shipment/invoice, Buyer will order a replacement part which will be invoiced in ordinary fashion. If the replaced part is returned to GPD Global by Buyer and found by GPD Global in its sole judgment to be defective, GPD Global will issue to Buyer a credit in the amount of the price of the replacement part. GPD Global’s acceptance of any parts so shipped to it shall not be deemed an admission that such parts are defective.

---

Specifications, descriptions, and all information contained in this manual are subject to change and/or correction without notice.

Although reasonable care has been exercised in the preparation of this manual to make it complete and accurate, this manual does not purport to cover all conceivable problems or applications pertaining to this machine.

# Getting started

---

To gain a complete understanding of how to set up and operate your Peel Back Force Tester (PBFT), GPD Global suggests reading the following sections:

- Tour [Introduction](#) (pg 2) to gain an understanding of the purpose of the PBFT, its theory of operations, and the location and name of its mechanical and software controls.
- Use [Installation](#) (pg 5) and [Configure & verify calibration](#) (pg 14) to properly install and prepare your PBFT for operations.
- Follow [Basic operations](#) (pg 20) to put your software-driven PBFT into operation.
- For a description of each element used in each window, refer to [Window references](#) (pg 56).

# Introduction

---

This document describes how to use the **PBFTVS.USB700** (variable speed Peel Back Force Tester with USB) and its FORCEWare control software. FORCEWare software drives the variable speed PBFT with SPC and collects data from it, or can demonstrate such operation. The PBFT provides reliable and accurate peel back force measurements of cover tape adhesion to surface mount component carrier tapes ranging in width from 8 mm to 56 mm.

The FORCEWare software package was designed by GPD Global to be compatible with Windows operating systems on either a desktop or notebook computer.

FORCEWare software was constructed for easy use with a variety of hardware. The software is not backward compatible with the DOS based software previously used with the PBFT (PBFT software and MASTERFORCE software).

## Function

The GPD Global PBFT accurately measures and records the peel-back force required to remove the cover tape from surface mount component carrier tape. It accommodates tape widths from 8 mm to 56 mm and accepts plastic, metal, and paper tape materials in single and dual sprocket configurations. Test results are recorded for incoming or outgoing taped components.

## Theory of operation

Set up involves loading and aligning a reel or strip of component carrier tape, verifying peel speed, configuring the printer, and, as needed, modifying test parameters.

Operations consist of zeroing out the strain gauge, logging onto the SPC software, setting the speed selector to the desired testing speed, and activating a test run.

Test results and speeds are recorded by the SPC software; the peel-back force is also displayed on the strain gauge LCD. Test results may be saved, printed, or reloaded for SPC analysis.

# Mechanical controls

Figure 1: PBFT VS - key elements (shown with Calibration Kit installed)

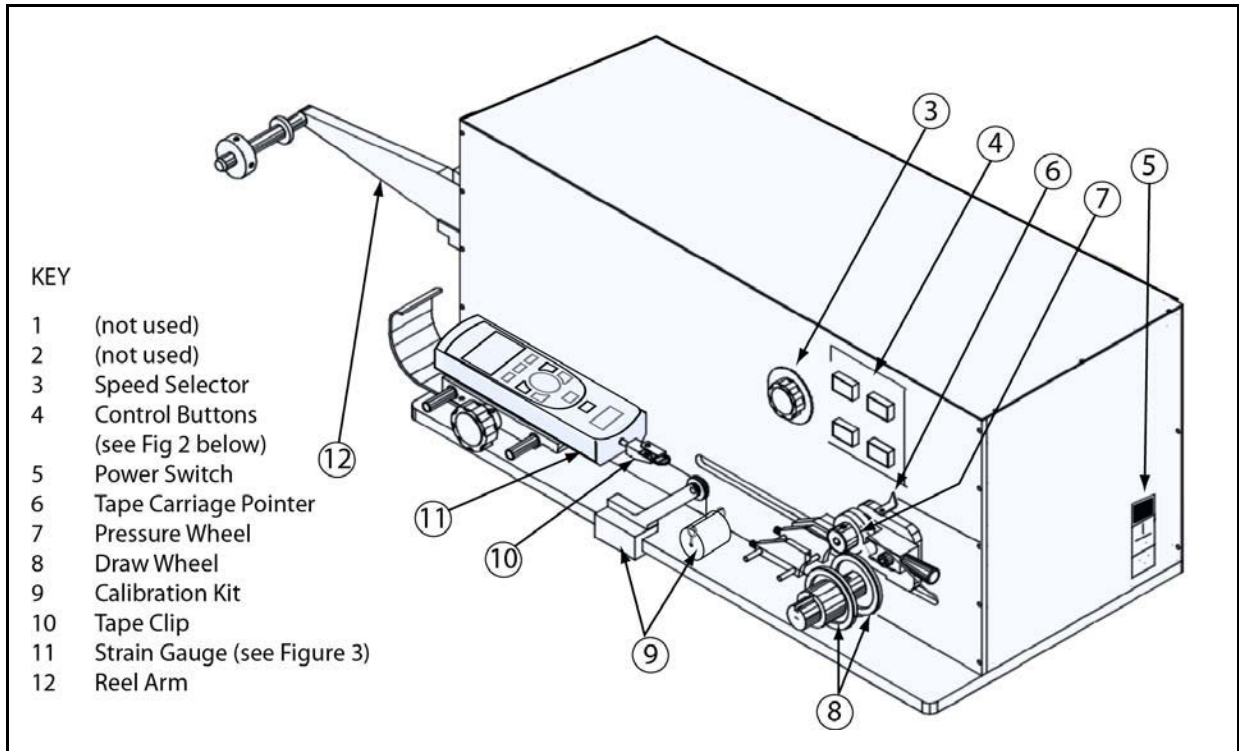

Figure 2: PBFT VS - control buttons

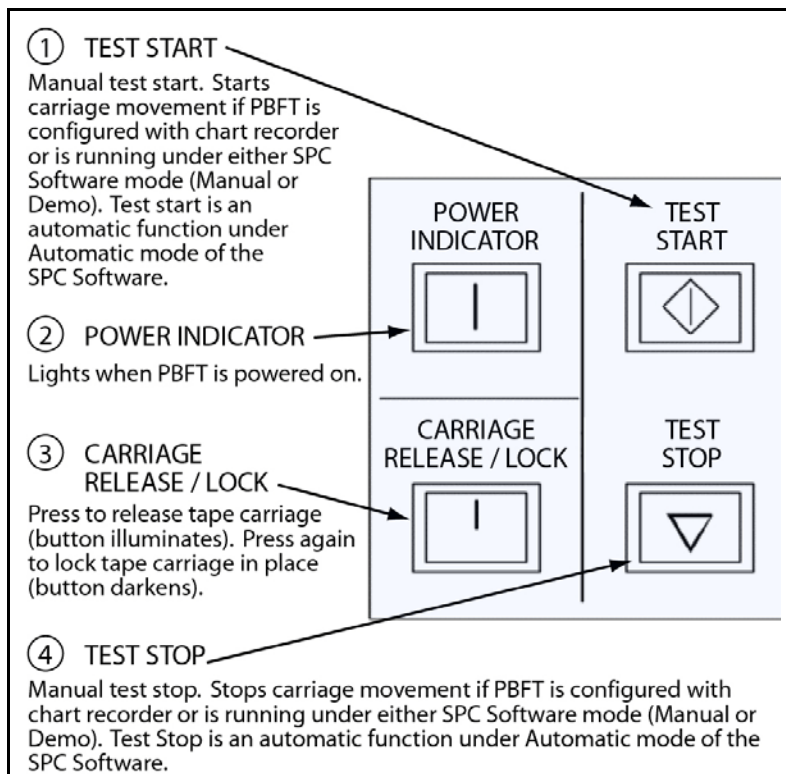
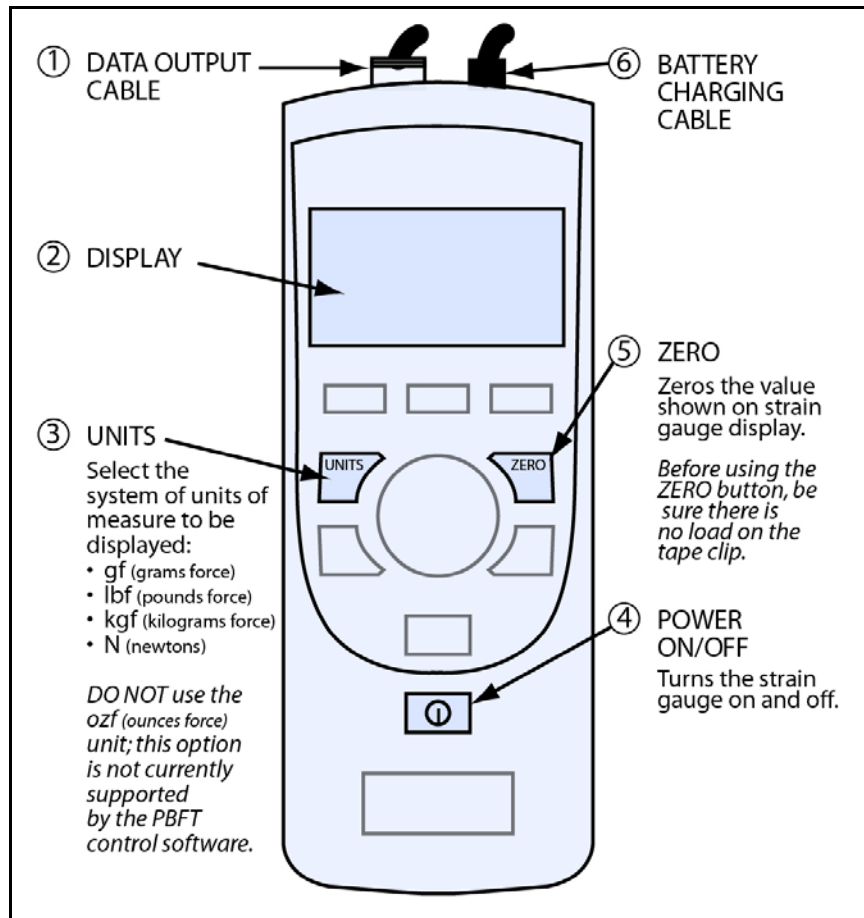

Figure 3: Strain Gauge - key elements



## Software controls

All FORCEWare software functions originate with the main window menu bar and its pull-down menus. Begin all setup, operation, analysis, and reporting functions at this main window.

A detailed description of each function is listed in [Window references](#) (pg 56).



# Installation

---

To utilize the FORCEWare software package, use the following installation procedures to:

- install provided hardware on your computer and, as applicable, on your PBFT;
- connect the computer and PBFT with the provided amplifier cable;
- download and install the software on your computer; and
- set up an initial user account.



**CAUTION:** Installation should only be performed by qualified maintenance or technical personnel fully aware of all safety precautions. Read all safety notices before proceeding with installation.



**IMPORTANT:** Perform all installation steps in the order presented in this manual.

## Installation summary

Installing your PBFT is a multi-step process. Perform all steps in the order listed.

- [1. Unpack & assemble](#) (pg 5)
- [2. Verify mechanical operations](#) (pg 6)
- [3. Download software & documentation](#) (pg 6)
- [4. Install & configure interface card software](#) (pg 7)
  - [4A. Install interface card software](#) (pg 7)
  - [4B. Install computer hardware](#) (pg 8)
  - [4C. Configure interface card software](#) (pg 8)
- [5. Install FORCEWare SPC software](#) (pg 11)
- [6. Initial start up](#) (pg 12)

## Installation procedure

### 1. Unpack & assemble

1. Carefully unpack machine - this is a PRECISION INSTRUMENT.
2. Place the machine on a stable, level surface.
3. Visually inspect the machine for any damage due to shipping. If any obvious damage is observed, contact the GPD Global Service Department.



**CAUTION:** Operation of a damaged machine may cause personal injury and/or invalidate the warranty.

4. Verify all accessories and documentation have been removed from crate and packaging.
5. Verify draw wheel ([Figure 1](#), Item 8) and pressure wheel ([Figure 1](#), Item 7) are in place.
6. Install the reel arm ([Figure 1](#), Item 12) with the provided screws.
7. Plug the PBFT power cord into the PBFT power outlet [located below the power switch ([Figure 1](#), Item 5)]. Plug the other end into a suitable power outlet. See [Specifications](#) (pg 100) for power requirement details.

## 2. Verify mechanical operations

1. Turn on the PBFT power switch. The power indicator ([Figure 2](#), Item 2) will light.
2. Verify that the strain gauge ([Figure 1](#), Item 11) is functional:
  - a. Verify the following cables are attached to the strain gauge:
    - Battery charging cable ([Figure 3](#), Item 6).
    - Data output cable ([Figure 3](#), Item 1).
  - b. Press and hold the strain gauge power on/off button ([Figure 3](#), Item 4) until a display ([Figure 3](#), Item 2) appears:
    - If the display fails to appear, let the PBFT recharge the strain gauge battery for 30 *minutes*. If after this time period the display still fails to appear, refer to [Troubleshooting](#) (pg 96) for suggested action.
    - If the display shows a message indicating the battery needs to be charged, let the PBFT recharge the strain gauge for *one hour*.
3. Verify that the tape carriage is functional:
  - a. Press CARRIAGE RELEASE/LOCK ([Figure 2](#), Item 3) to release the tape carriage.
  - b. Manually position the tape carriage pointer ([Figure 1](#), Item 6) with the zero (0) mark on the Length of Test scale (see below).

*Align tape carriage*

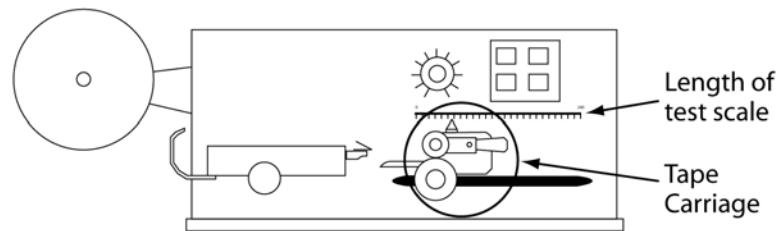

- c. Press CARRIAGE RELEASE/LOCK to lock the carriage in place.
- d. Select a speed on the speed selector ([Figure 1](#), Item 3).
- e. Press TEST START ([Figure 2](#), Item 1). The following should occur:
  - Tape carriage will automatically travel to the end of its range and stop.
  - The TEST START lamp will darken.



**CAUTION:** If the TEST START light does not darken, IMMEDIATELY turn off the power switch and contact the GPD Global Service Department.

## 3. Download software & documentation

To download software and documentation onto your hard drive:

1. Download **.zip** file from the URL noted in the *Download Instructions* document (PN 2050-0089) accompanying your machine. The required user ID and password are also included in this document.
2. Expand **.zip** file.
3. Run **.msi** file.

## 4. Install & configure interface card software

The InstaCal interface card software must be installed prior to installation of the PBFT control software (FORCEWare software). InstaCal sets up the interface card and enables testing of card functionality.

### 4A. Install interface card software

To install the InstaCal interface card software:

1. Double click on the **icalsetup.exe** file included in the .zip file you downloaded in [3. Download software & documentation](#) (pg 6).
2. Follow instructions presented in the series of “InstaCal for Windows” screens that display.

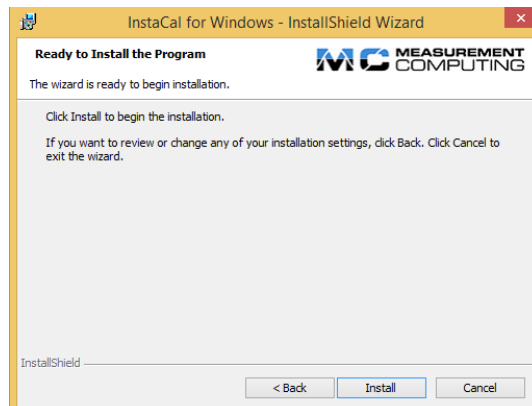
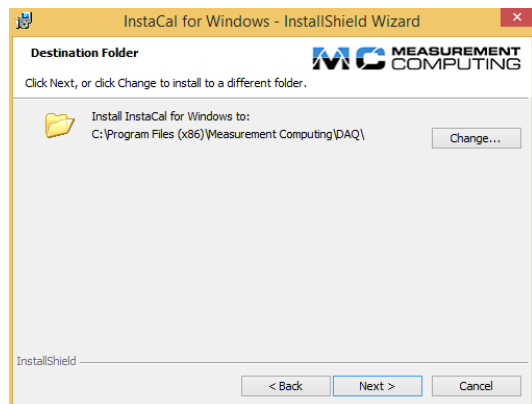
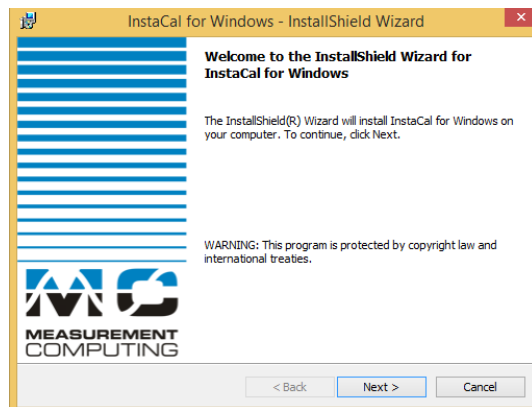



- When the following window displays, select YES and click OK. The computer will automatically boot and install the appropriate driver for the new software.

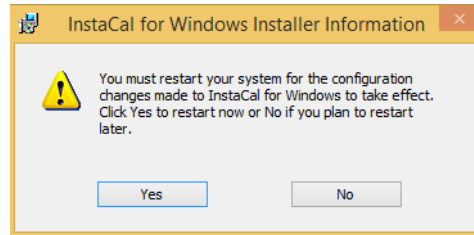

#### 4B. Install computer hardware

Installation requires connecting the PBFT interface cable to a USB 2.0 compatible port in a compatible desktop or notebook computer. For hardware requirements, see [Requirements](#) (pg 100).

- If you are installing FORCEWare software as a retrofit, remove the existing converter card from the computer; otherwise, skip this step.
- Plug the interface cable into an available USB 2.0 compatible port.

 **IMPORTANT:** Do NOT use USB port extension devices (hub). Plug the interface cable directly into the computer USB port or a laptop computer USB port.

#### 4C. Configure interface card software

The InstaCal interface card software must be configured prior to installation of the FORCEWare software - the PBFT control software.

To configure the InstaCal interface card software:

- Run InstaCal by clicking on Start > Programs > Measurement Computing > InstaCal. The following window displays.

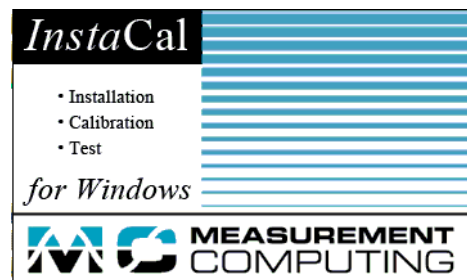

2. When windows similar to the following display, click OK on the Plug and Play Board Detection window.

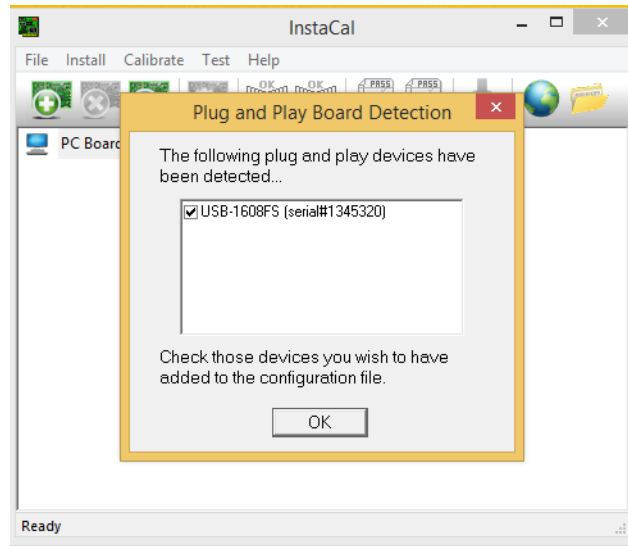

3. A window similar to the following will display.

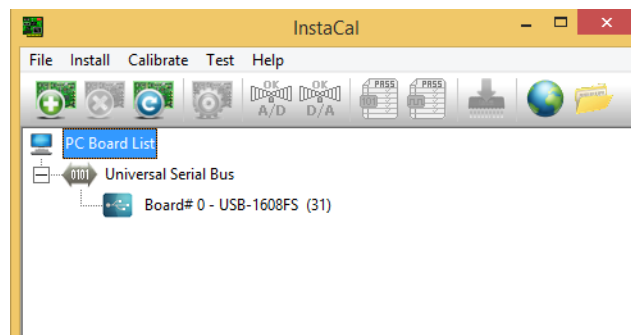

- f. Click on Install > Remove All, and then click OK.

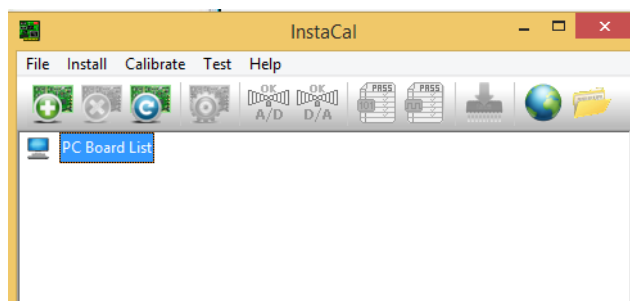

- g. Close the InstaCal window.

4. Select the primary board:
  - a. Restart the InstaCal program by clicking on Start > Programs > Measurement Computing > InstaCal.
  - b. Click OK on the Plug and Play Board Detection window. A window similar to the following should display with only the USB-1608FS board listed and labeled as board #0.

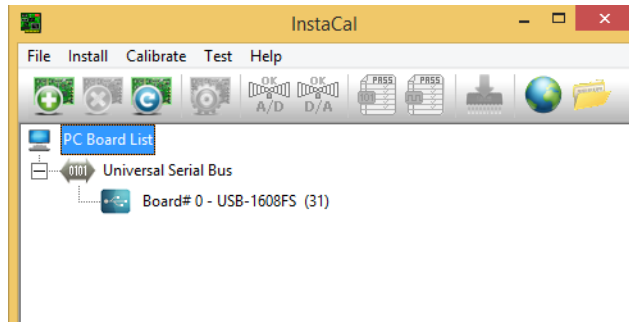

5. Power on the PBFT and strain gauge:
  - a. Turn on the PBFT power switch. The power indicator ([Figure 2](#), Item 2) will light.
  - b. Press and hold the strain gauge power on/off button ([Figure 3](#), Item 4) until a display ([Figure 3](#), Item 2) appears.
6. Test the interface card/strain gauge/cable setup:
  - a. Click on Test > Analog.
  - b. Select a Signal Source of EXTERNAL and click OK. Spikes in the line, prior to selecting EXTERNAL, are normal due to random environmental noise. Spikes should disappear once EXTERNAL is selected.

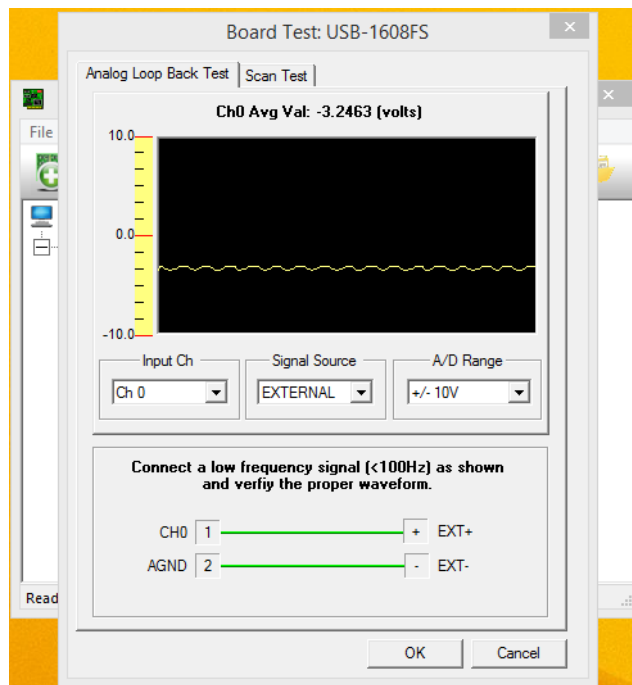

- c. Apply force to the strain gauge. The Analog Loop Back Test panel should display strain gauge changes. If changes are not evident, check for power to the PBFT and Strain Gauge and repeat interface card setup to verify correct configuration. If problems persist, call the GPD Global Service Department.
7. Exit InstaCal software.

## 5. Install FORCEWare SPC software

To install FORCEWare SPC software:

1. Verify that InstaCal interface card software has been installed. If you have not already done so, install the interface card per [4A. Install interface card software](#) (pg 7).

 **IMPORTANT:** The InstaCal interface card software must be installed prior to installing the FORCEWare SPC software.

2. If a **prior** version of FORCEWare software was previously installed, remove it prior to installing the **current** version of FORCEWare software.

 **IMPORTANT:** It is strongly recommended that any previous versions of FORCEWare software be removed prior to installation of a newer version of FORCEWare software. All software versions prior to 5.6.0 are incompatible with hardware issued beginning with serial number 8561000. Software versions 5.6.0+ are compatible with both old and new hardware.

3. Double click on the **FORCEWare.msi** file included in the .zip file you downloaded in [3. Download software & documentation](#) (pg 6).
4. A series of standard installation windows will display - follow the instructions as presented.
5. The PBFT/FORCEWare Configuration Utility window displays and allows configuring of the FORCEWare software to the PBFT hardware for proper system operation.

### Standard configuring

In the Configure tab, enter the PBFT serial number. Or, if a USB upgrade kit (PN PBT-118-1, PBT-118-2, PBT-118-3, or PBT-118-4) is being used, enter the serial number for the USB upgrade kit. Then click FINISH.

**NOTE:** If the serial number is not accepted, contact the GPD Global Service Department for instructions on how to proceed.

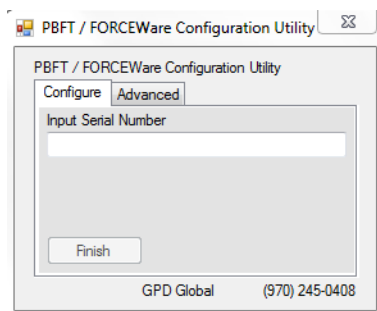

### Advanced configuring

**IMPORTANT:** This method is for use by qualified personnel only.

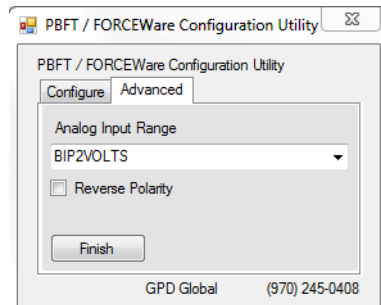

#### **Analog Input Range:**

configure voltage range of the analog input channel for the strain gauge.

#### **Reverse Polarity:**

determines how FORCEWare software interprets the polarity of strain gauge signal.

- unchecked - the software will interpret an increasing voltage value as an increase in force.
- checked - the software will interpret a decreasing voltage value as an increase in force.

(To uninstall FORCEWare software, refer to [Uninstall FORCEWare software](#) (pg 98).)

## 6. Initial start up

Create a password for the administrator login. The administrator login provides access to the Account Manager screen.

For initial access to the program:

1. Create a password for the administrator login:
  - a. Start the FORCEWare application. The main login screen appears.

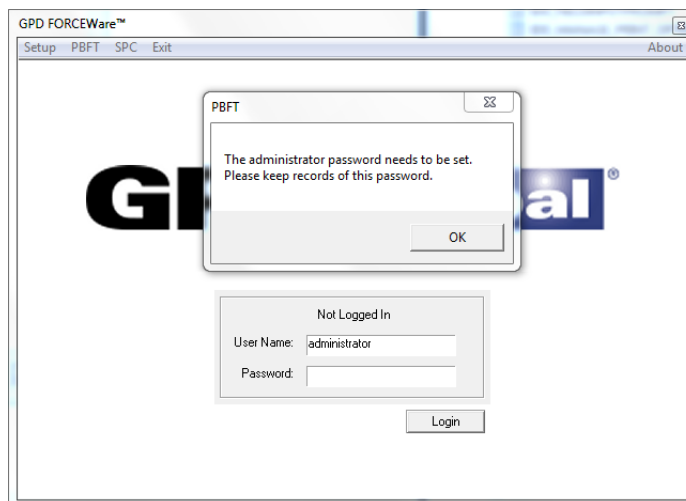

- b. Enter 'administrator' in the User Name field.

- c. A prompt for the administrator password displays. Input the desired password and click OK.

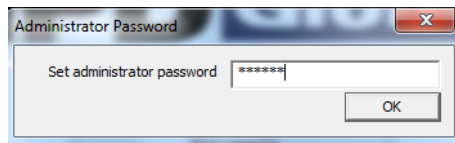

- d. Re-enter the password for confirmation, and then click OK.

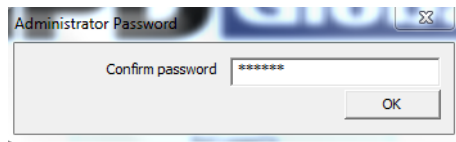

**NOTE:** Keep a record of this password. If you lose the administrator password, the only recourse is to uninstall and then reinstall the FORCEWare software to clear the password user data is preserved).

2. The Accounts tab of the Account Manager window appears.

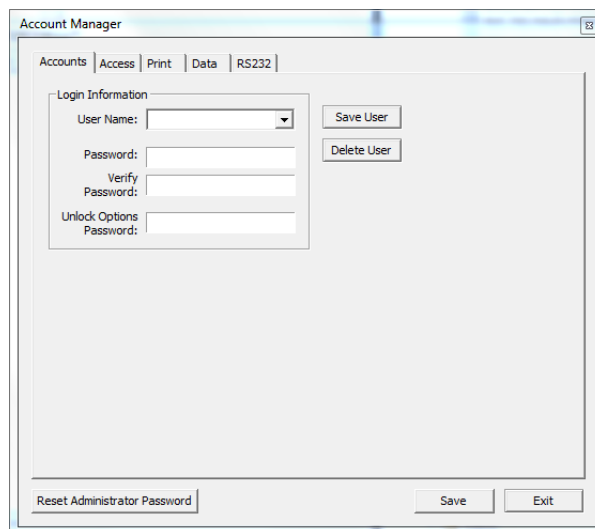

3. As necessary, set up additional user names and the corresponding passwords and access rights. See [User access](#) (pg 49) for details.
4. Set the defaults in the Print tab. For details, [Account Manager - Print](#) (pg 63).
5. Set the defaults in the Data tab. For details, see [Account Manager - Data](#) (pg 61).
6. Click SAVE USER to create or update the settings for the currently selected User Name.
7. Press EXIT to exit the FORCEWare software. Notice the “Not Logged In” status message that now displays above the User Name field.

You may now log on as the administrator using the new administrator password.



**IMPORTANT:** Prior to operating the PBFT, the software MUST be configured and verified. Refer to [Configure & verify calibration](#) (pg 14).

# Configure & verify calibration

---

Generally, the following procedures for configuring the PBFT and verifying calibration of its speed control and strain gauge to the FORCEWare control software are performed only for initial start up. However, if accuracy performance deteriorates, these procedures should be repeated: [2 - Verify PBFT speed](#) (pg 15) and [3 - Verify PBFT strain gauge](#) (pg 18). These procedures may be performed on a regular basis to prevent accuracy problems from developing.

## Configure & verify calibration summary

Configuring and verifying calibration of your PBFT is a three step process. Perform all steps in the order listed.

[1 - Configure PBFT with computer](#) (pg 15)

[2 - Verify PBFT speed](#) (pg 15)

[3 - Verify PBFT strain gauge](#) (pg 18)

## Configure & verify calibration procedure

### 1 - Configure PBFT with computer

To configure the PBFT with the computer interface card:

1. Verify both the computer and PBFT are powered on.
2. If not already done, perform [6. Initial start up](#) (pg 12).
3. Perform the [3 - Verify PBFT strain gauge](#) (pg 18) procedure.

### 2 - Verify PBFT speed

Verifying the PBFT speed dial requires repeating a simple procedure for each speed setting. First, set the mechanical speed selector to a speed, then select the corresponding software speed value, and finally, click on the software Calibrate button.

To verify the FORCEWare software to the PBFT speed indicator:

1. If this is an initial set up, first perform the preceding [Configure & verify calibration summary](#) (pg 14) procedure.
2. From the main window menu bar, click on Setup > Calibrate Speed. The Calibrate Speed window appears.

*Configuration 100 mm to 600 mm - prior to calibration or in reset condition.*

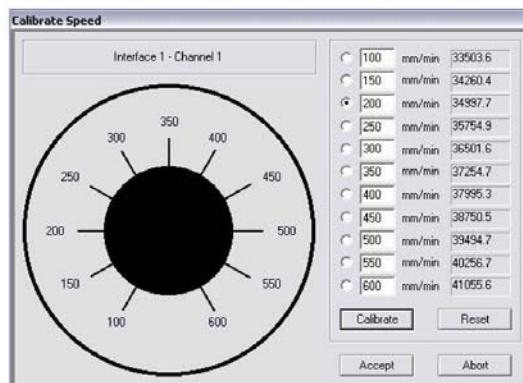

*Configuration 100 mm to 300 mm - prior to calibration or in reset condition.*

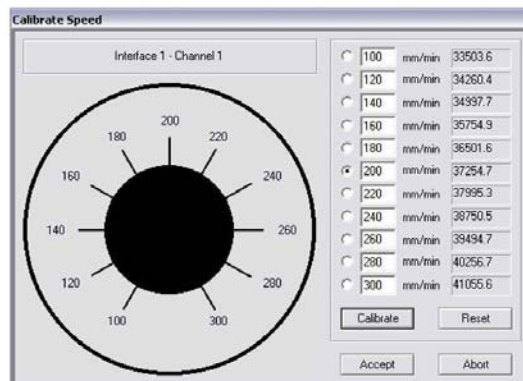



3. Verify speeds:
  - a. First, verify that the speed range shown in the Calibrate Speed window matches the speed range on the speed dial hardware. Speeds will range either from 100 to 300 or from 100 to 600.

*The maximum speed should be the same on the hardware knob and in the software.*

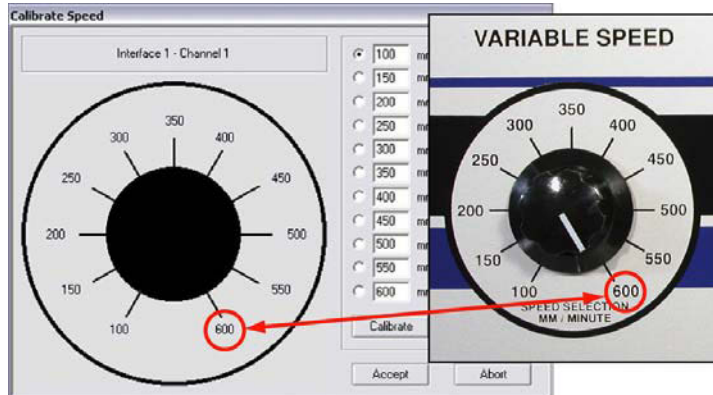

- b. If the maximum speed on the speed dial hardware is 600 mm, skip to step 4; otherwise, continue with the following 3.c.
- c. If the maximum speed is 300 mm, you may need to input speed settings to match the hardware:
  - Compare the individual settings in the speed fields displayed in the Calibrate Speed window to the hardware dial speeds. They should match the values shown below.
  - If the speed settings in the Calibrate Speed window do not match, input the following values: 100, 120, 140, 160, 180, 200, 220, 240, 260, 280, and 300.

*The speeds on the simulated dial should match those positioned around the hardware dial.*

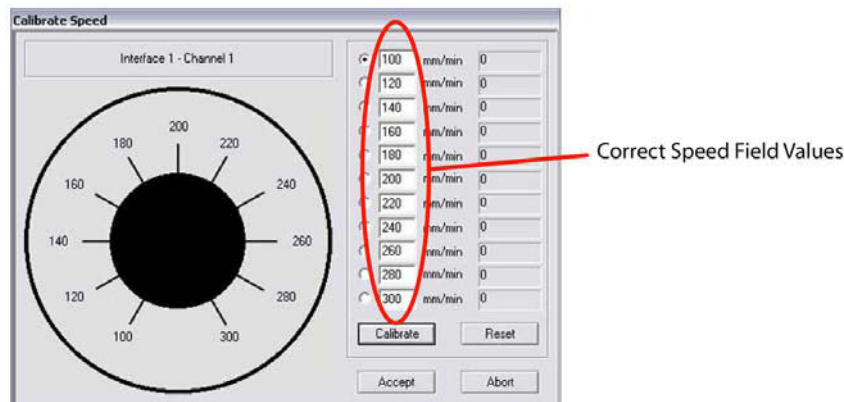

4. Coordinate the hardware Speed Selector dial with the selected speed:
  - a. Turn the Speed Selector dial on the PBFT until it points to the selected speed.
  - b. Click the CALIBRATE button displayed in the window (using either the mouse or press ENTER on the computer keyboard).
  - c. Repeat steps 4.a. and 4.b. until all speeds have been calibrated. When calibration for the selected speed succeeds, the next speed to calibrate will be selected. An error message occurs if you attempt to calibrate the same hardware dial position at two or more speeds.

- d. When complete, the window should look similar to the one below with values to the right of each speed designation. The values now displayed are in raw data format for the interface card.

*Configuration 100 mm to 600 mm - speed values should differ by a consistently similar incremental amount.*

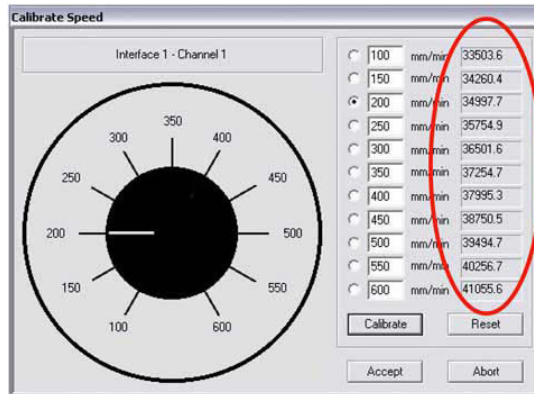

*Configuration 100 mm to 600 mm - speed values should differ by a consistently similar incremental amount.*

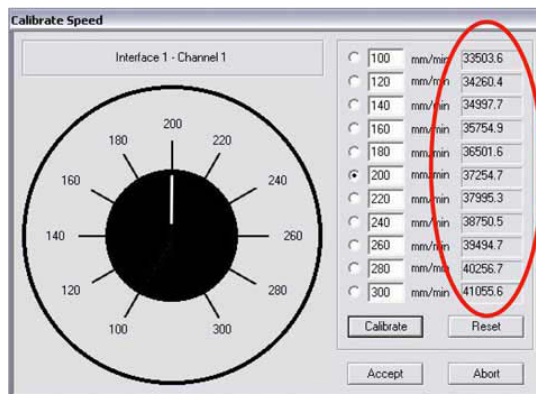

- e. The incremental difference between the displayed values should be a consistently similar amount. If they are not, re-calibrate the PBFT by clicking on RESET and then repeating step 4.
5. When you are satisfied with the displayed calibration values, verify that the PBFT Speed Selector dial and the simulated dial are synchronized. For example, notice that the simulated dial in the previous illustration is set to 200 mm/min. This should indicate that the Speed Selector dial on the PBFT is set to 200 mm/min.

The dials are coordinated if, as you turn the Speed Selector dial on the PBFT in turn to each speed increment, the simulated dial responds by changing to the same setting. If this is not the case, click RESET and repeat steps 4 and 5.

6. Click ACCEPT to save the changes.

### 3 - Verify PBFT strain gauge

Calibrating the control software with the PBFT strain gauge is simply a matter of first calibrating the software without a load on the strain gauge and then calibrating the software again with a load (a weight in the upper range) on the strain gauge. Use the GPD Global Strain Gauge Verification Kit (PBT-123) to verify strain gauge operations.

To calibrate the FORCEWare software to the PBFT strain gauge:

1. If this is an initial set up, be sure to first complete the *Verify PBFT Speed* procedure; otherwise, skip to the next step.
2. From the main window menu bar, click on Setup > Calibrate Strain Gauge. The Calibrate Strain Gauge window appears.

*Setting prior to strain gauge verification.*

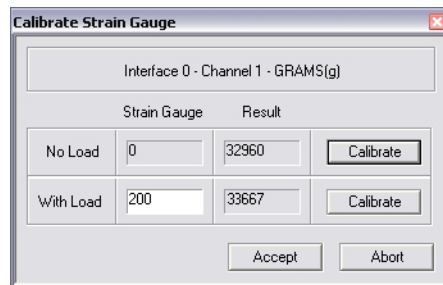

3. Prepare the PBFT strain gauge:
  - a. Verify that the PBFT strain gauge is powered on.
  - b. With no load on the strain gauge, press the strain gauge ZERO button.

**⚠ CAUTION:** Use only the strain gauge buttons specified by these instructions. Use of strain gauge buttons and programming beyond what is designated in these instructions could adversely affect strain gauge performance.

- c. Verify the unit of force (g, kg, N, or lb) displayed by the strain gauge is the same unit of measure displayed across the top of the Calibrate Strain Gauge window. If they do not agree, either change the unit of force in the user account to agree with the strain gauge or calculate the conversion when asked to enter the strain gauge reading.

**NOTE:** Do not use the ozf unit of measure offered by the strain gauge as this option is not currently supported by FORCEware software.

4. Click the CALIBRATE button in the No Load row of the Calibrate Strain Gauge window.

*Verify the strain gauge with NO load.*

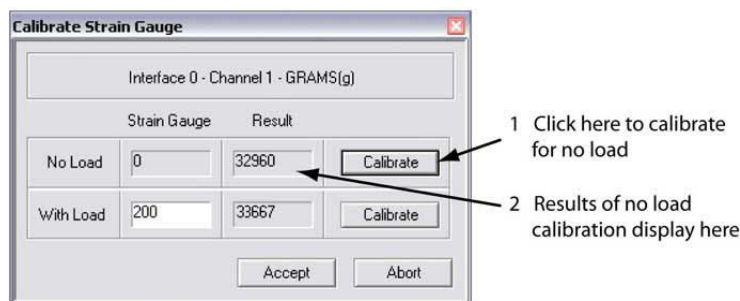

- Place a load on the strain gauge and allow the weight to stabilize. Note the value of the strain gauge reading.

**NOTE:** A maximum load of 150-200 grams is recommended.

- Enter the value of the strain gauge reading in the Strain Gauge field of the With Load row. Then click on the CALIBRATE button in the same row.

Verify the strain gauge *WITH* a load.

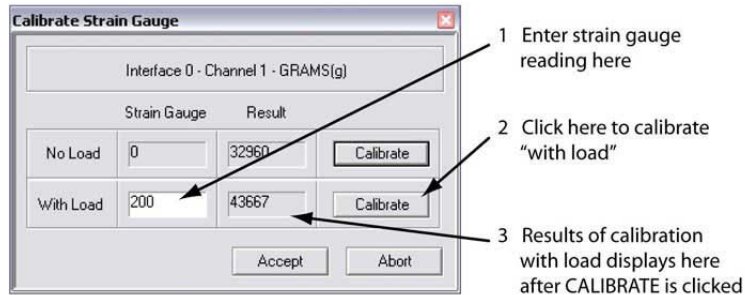

Results similar to those shown above should display. If an "Unacceptable Range" prompt appears, click CANCEL and repeat steps 5 and 6. Check to be sure the same unit of force is being used in the software and on the strain gauge. If the message continues to appear, use a lighter load on the strain gauge.

- Click ACCEPT in the Calibrate Strain Gauge window. Calibration is now complete.

# Basic operations

---

## Basic operations summary

Operating your PBFT requires the following nine basic steps. Perform all steps in the order listed:

[1 - Start up](#) (pg 21)

[2 - Verify speed](#) (pg 22)

[3 - Configure printer](#) (pg 23)

[4 - Open PBFT control center](#) (pg 26)

[5 - Modify test parameters](#) (pg 27)

[6 - Load carrier tape](#) (pg 28)

[7 - Run a test](#) (pg 30)

[8 - Additional operations](#) (pg 32)

# Basic operations procedure

## 1 - Start up

 **IMPORTANT:** You must perform the [Configure & verify calibration summary](#) (pg 14) prior to initial operations.

Power on equipment and login to the control software:

1. Power on and setup the PBFT and its strain gauge:
  - a. Verify the PBFT power switch ([Figure 1](#), Item 5) is turned on.
  - b. Turn the speed selector ([Figure 1](#), Item 3) to desired testing speed.
  - c. Press and hold the strain gauge power on/off button ([Figure 3](#), Item 4) until a display ([Figure 3](#), Item 2) appears.
  - d. Verify the strain gauge is set to the desired unit of measure. If not, select desired units with the UNITS button ([Figure 3](#), Item 3).
  - e. Press ZERO ([Figure 3](#), Item 5) on the strain gauge. The display should read zero.
2. Power on the computer configured for use with the PBFT.
3. Open the FORCEWare software by clicking on START > GPD Global > FORCEWare. (The Windows START button is located in the screen's lower left hand corner.)
4. Log on using a user account with the appropriate access rights for the operations to be performed:
  - a. In the main window, type in a user name and password.
  - b. Click on LOGIN. The text above the user name field changes to "Logged in: [user name]".



## 2 - Verify speed

Verify the PBFT Speed Selector dial and the simulated software dial are synchronized:

1. In the main window menu bar, click on Setup > Calibrate Speed. The Calibrate Speed window appears.
2. Turn the Speed Selector dial on the PBFT, in turn, to each speed increment. At the same time, note the response of the simulated dial; it should respond by changing to the same setting.

*The white pointer on the simulated dial should change position to agree with the actual speed selected on the PBFT.*

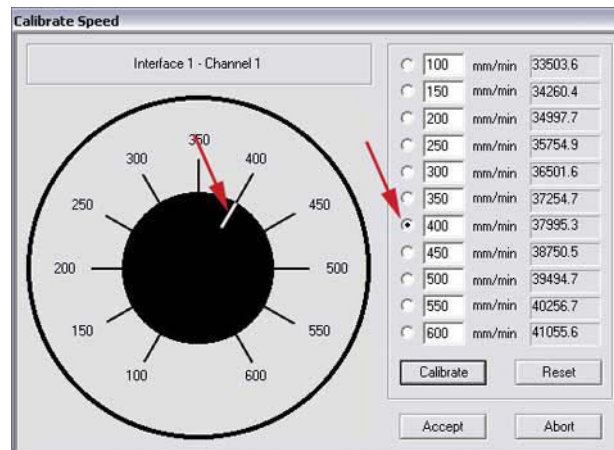

3. Choose one:
  - If the dials are synchronized properly, click ABORT.
  - If the dials are NOT synchronized properly, perform [2 - Verify PBFT speed](#) (pg 15).

### 3 - Configure printer

As needed, you may change the printer configuration defaults for report dimensions and appended report text. These defaults can be overridden from the Print tab of the Create Preset window by users with access to that area. For samples of sized reports and reports with appended text, refer to [Report & label samples](#) (pg 46).

To change printer configuration:

1. From the main window menu bar, click on Setup > Configure Accounts.
2. In the Accounts tab, select the user name for which you want to configure printer defaults. Enter the corresponding password.
3. Click on the Print tab.

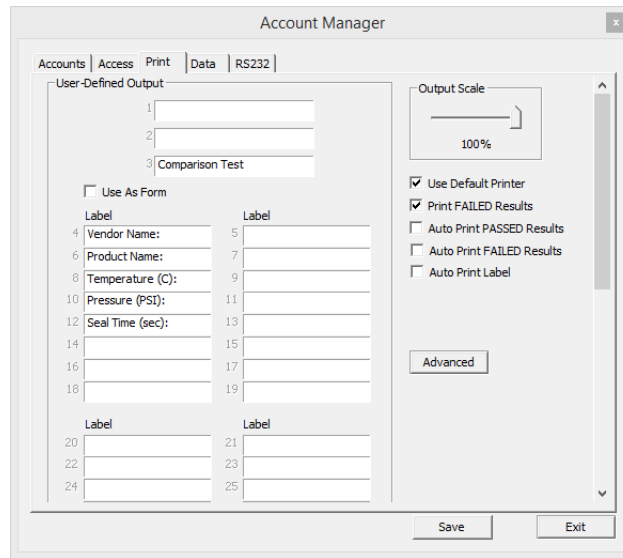

4. As needed, change report dimensions by sliding the Output Scale slider to the desired percentage of full size.
5. Choose a label or form output based on the Use As Form description in [Account Manager - Print](#) (pg 63).

<b>OUTPUT A: Labels for Labels or Files</b>	<b>OUTPUT B: Form Prompts at Start of Test</b>
<p>To select labels for printed documents or for naming format of data file output:</p> <p>--&gt; disable (uncheck/blank) the Use As Form check box.</p>	<p>To select that the user be prompted to input a value when a test is run:</p> <p>--&gt; enable (check) the Use As Form check box.</p>

6. As needed, add, change, or delete text in any of the fields in the User-Defined Output panel.
7. As needed, use the advanced printer configuration to design your own report and label format. For details, refer to [Advanced printer configuration](#) (pg 24).
8. When all changes are complete, select the Accounts tab and click SAVE.



### Advanced printer configuration

The Advanced Printer Configuration window lets you customize the format of reports and labels by defining the content and the order in which the content prints on the report or label. Basically, report format is defined in the Results Format panel, label format is defined in the Label Format panel, and the variables available for use in both format panels are listed in the Legend panel. Once your report or label is formatted, you can adjust the printed line spacing using the Text Spacing slider.

To customize the format of a report or label:

1. Open the Advanced Printer Configuration window:
  - a. If the Print tab of the Account Manager window is not already open:
    - Go to the main window menu bar and click on Setup > Configure Accounts.
    - Select the user name for which you want to configure printer defaults. Enter the corresponding password.
    - Then select the Print tab of the Account Manager window.
  - b. Click on the ADVANCED button. If the Advanced Printer Configuration window does not open, then it has been password protected in the Access tab of the Account Manager User window.
2. Format a report or label:
  - a. Type text in the Results Format panel (for reports) or in the Label Format panel (for labels) exactly the way you want it to appear when printed.
  - b. Make use of the Legend variables by typing the pound symbol (#) and the variable numeral wherever you want “data associated with that variable” to print. Review how variables are used in the label format in the graphic below:

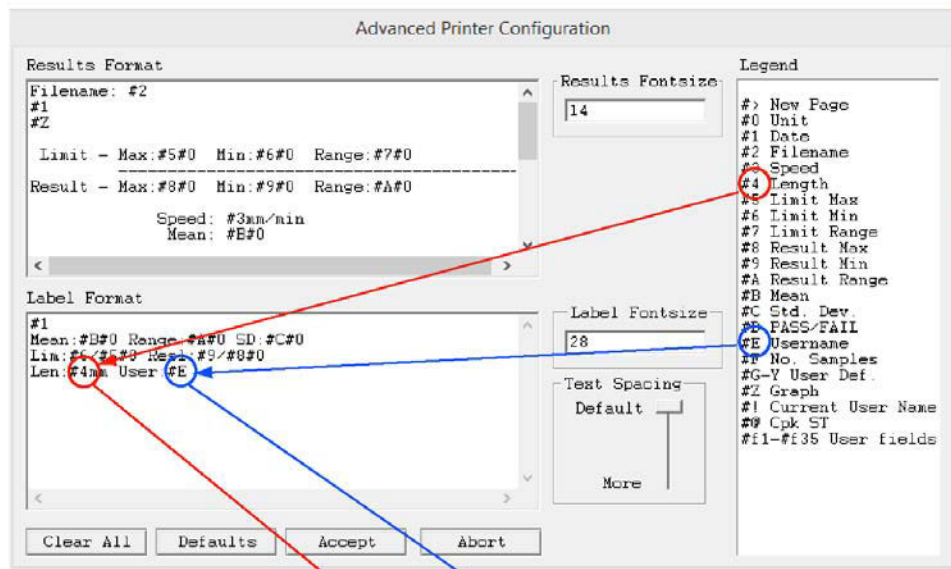

#### Using Legend Variables to Format Printed Results

Assuming test length is “100” and User Name is “Demo”, note how the Legend variables correlate to the defined format and printed results.

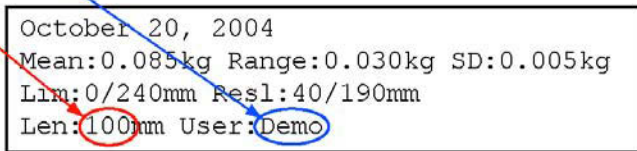

Another example: Notice that Legend variable #1 equates to date and variable #2 equates to file name. These variables equate to the file name and test date of a particular peel test. If you were to type the following in the Results Format panel:

```
Filename: #2  
#1
```

and, assuming the test date is 10/20/05 and the file name is TEST FILE, then the resulting report would look like this:

```
Filename: TEST FILE  
10/20/05
```

3. As needed, use the Text Spacing slider to adjust the height of the space between the lines of printed text.
4. To save your changes to the Print tab and exit the Advanced Printer Configuration window, click on ACCEPT. To exit without saving changes, click on ABORT.
5. To save your changes for the currently selected user name, go to the Accounts tab and click SAVE USER. Then click on EXIT to exit the Account Manager window.

## 4 - Open PBFT control center

From the main menu bar, click on PBFT > Activate PBFT. The PBFT Control Center window appears.

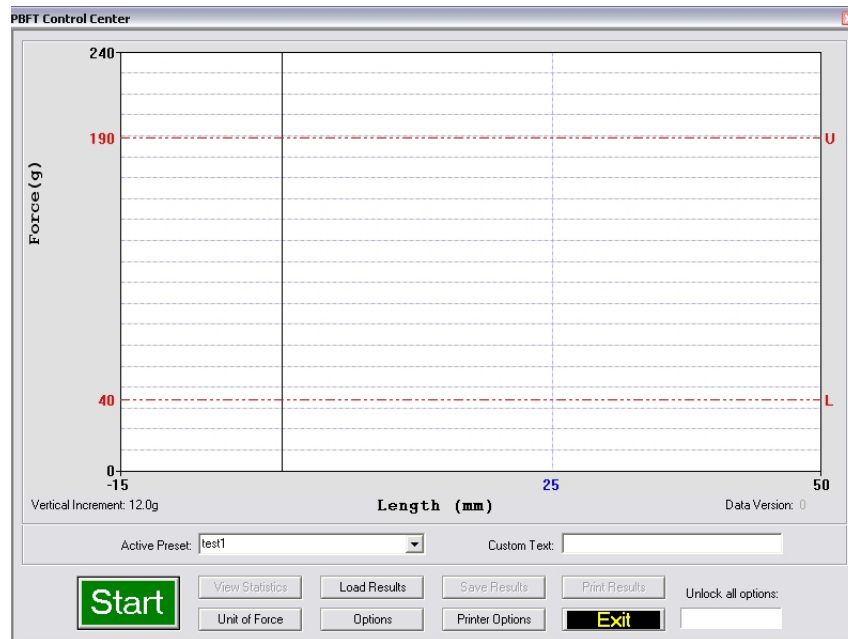

For user accounts with the appropriate access rights, the OPTIONS, LOAD RESULTS, and UNIT OF FORCE buttons will be available for use. For further details about these options, refer to [8 - Additional operations](#) (pg 32).

## 5 - Modify test parameters

As needed, change the test parameters:

1. Click the OPTIONS button in the PBFT Control Center window. The Test Parameter Options window appears.

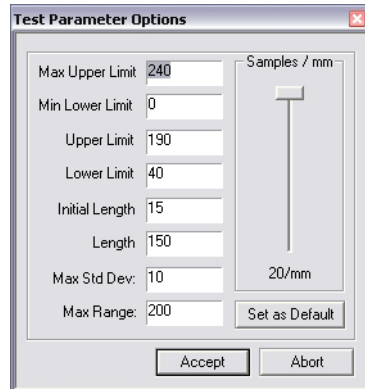

2. As needed, change parameters and the Samples/mm setting. When entering parameters, enter the data in keeping with the current unit of force. Slower computers may require a lower sampling setting, i.e., decrease the number of Samples/mm.
3. Click ACCEPT.

## 6 - Load carrier tape

Load the PBFT with carrier tape according to standard operating procedures:

### Prepare PBFT

1. Verify the PBFT is turned on.
2. Place a reel of component carrier tape on the reel arm ([Figure 1](#), Item 12).
3. Align the tape carriage:
  - a. Press CARRIAGE RELEASE/LOCK ([Figure 2](#), Item 3) until it lights. The tape carriage should move freely.
  - b. Manually move the tape carriage toward the left until its pointer ([Figure 1](#), Item 6) aligns with zero (0) on the Length of Test scale.

*Align draw wheel carriage.*

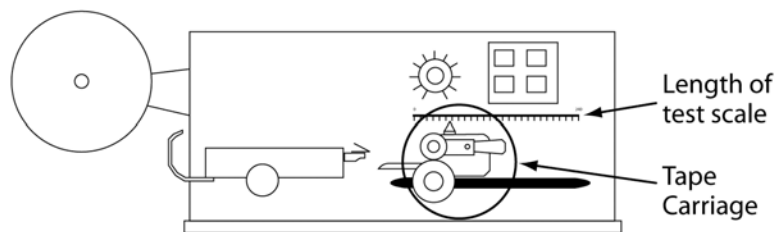

### Load tape

1. Feed carrier tape (figure below, Item 1) under the tape deflector (Item 2) to the tape carriage (Item 4).
2. Gently peel back a short length of the cover tape (Item 3) from the carrier tape.

*Feed tape to tape carriage.*

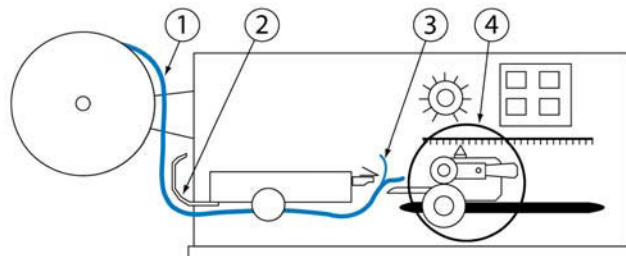

3. Feed carrier tape through tape carriage:
  - a. Press the draw wheel handle (see figure below, Item 3) down and push the spring-loaded knob (Item 2). This locks the draw wheel rollers (Item 1) in the open position.

*Tape carriage.*

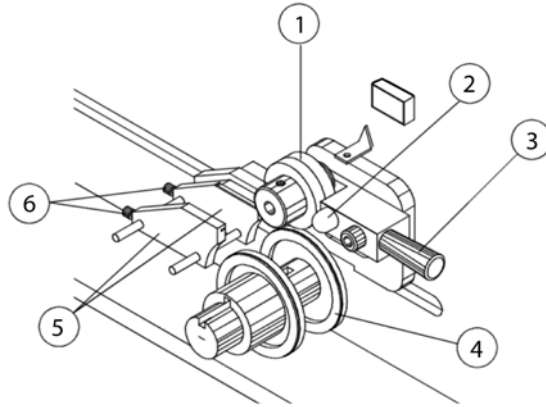

- b. To accommodate the width of the carrier tape, use the adjustment screws (Item 6) to adjust the tape guides (Item 5). The tape must feed through the guides with a minimum of resistance or else peel back force values will be affected.
  - c. Lay the tape over the draw wheel (Item 4), aligning the tape holes with the draw wheel pins.
  - d. Release the draw wheel rollers by pushing down on the draw wheel handle. The spring-loaded knob releases the rollers to hold the tape in place.
4. If necessary, use the adjusting knob (see figure below, Item 1) to align the lateral position of the strain gauge so the strain gauge clip (Item 2) is in-line and centered with the tape in the tape carriage.

*Feed and align tape.*

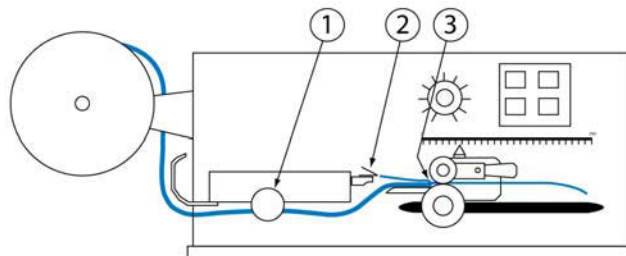

5. Grasp the cover tape and gently peel back a length just long enough to reach from the draw wheel to the strain gauge clip.
6. Secure the end of the cover tape in the clip. Verify that the peel back point (Item 3) is within 40 mm of the draw wheel.

**⚠ CAUTION:** DO NOT strike or jar the strain gauge. Apply pressure to the strain gauge clip in a gentle pulling or pushing motion, not by hitting or jarring it. Applying force to this precision instrument at an excessive speed may result in permanent damage to the unit.

**⚠ CAUTION:** DO NOT apply force to the strain gauge beyond recommended limit of 1 kg for standard strain gauge or 0.25 kg for 250g strain gauge. Applying excessive weight to this clip, which measures the peel back force of the cover tape, may result in permanent damage to the unit.

## 7 - Run a test

To run a peel back force test:

1. Select either the current user or a preset from the Active Preset drop-down menu. For details about presets, refer to [Presets](#) (pg 43). Your selection determines which set of parameters will be applied to the test run.
2. Click the START button in the PBFT Control Center window. When the test starts, the appearance of the START button will change – it becomes a STOP button. You may stop the test at any time by clicking on the STOP button or pressing ENTER on the keyboard.

*Ready to run test - click on START.*

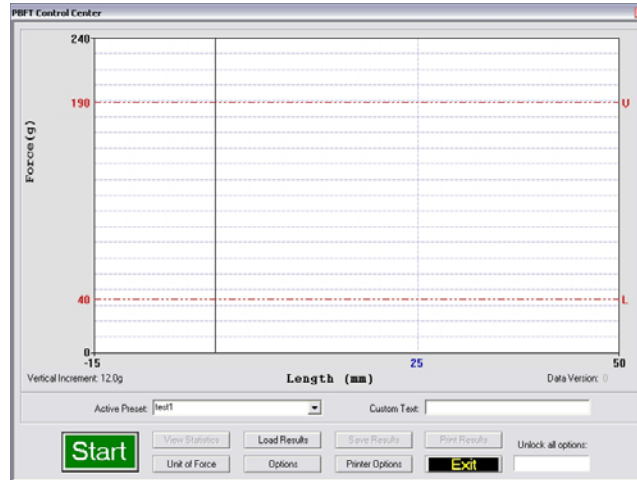

*Test stopped by clicking on STOP.*

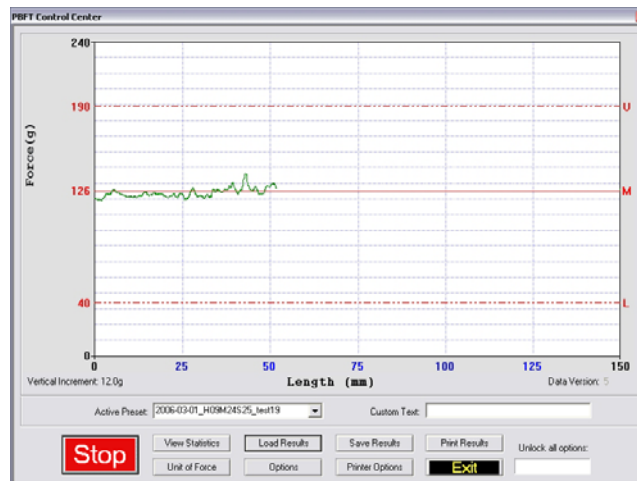

- When the test is complete, a Test Results window appears.

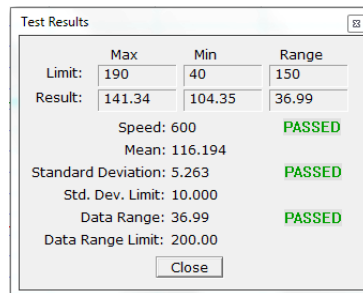

The screenshot shows a window titled "Test Results" with a close button in the top right corner. The window contains a table with three columns: "Max", "Min", and "Range". Below the table, there are several rows of data, each followed by a "PASSED" status in green text. At the bottom of the window is a "Close" button.

	Max	Min	Range
Limit:	190	40	150
Result:	141.34	104.35	36.99
Speed:	600		PASSED
Mean:	116.194		
Standard Deviation:	5.263		PASSED
Std. Dev. Limit:	10.000		
Data Range:	36.99		PASSED
Data Range Limit:	200.00		

At this point, you have the following choices:

- Note the Pass or Fail status and then click CLOSE to exit Test Results.
  - Note the PBFT Control Center window - the mean is now displayed on the graph, indicated by a solid red line followed by the letter M.
  - To view these test results again, click the VIEW STATISTICS button in PBFT Control Center.
  - If errors were made while entering user-defined field and output data prior to running the test, you may (with proper access permissions) modify the data by clicking on the USER FIELDS button. No statistical data can be modified. For complete details, refer to [Login](#) (pg 77) and [User Defined Fields](#) (pg 87).
- Choose one:
    - To save or print results, continue with [Save test results](#) (pg 32) and/or [Print test results](#) (pg 34).
    - To exit the PBFT Control Center window and return to the main window, click EXIT.



## 8 - Additional operations

After a test is run, various operations are available with the proper password access: saving and printing test results, saving log files, changing the unit of force, loading previous test results, and SPC analysis.

### Save test results

To save test results:

1. Click SAVE RESULTS in the PBFT Control Center window. Data Storage appears. If a prompt to set a default path appears, click OK or press ENTER to continue.

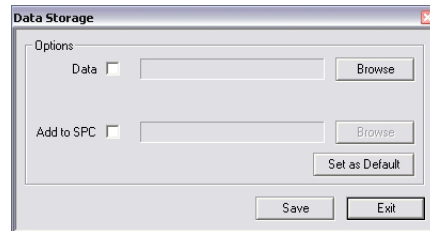

2. To select a path:
  - a. Enable the appropriate check box (Data or Add to SPC).
  - b. Click the corresponding BROWSE button. A window similar to the following one appears.

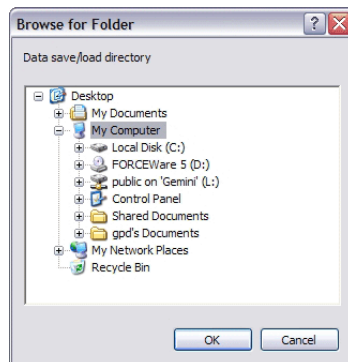

- c. Locate and select the directory into which you wish to save the file, then click OK. The selected path appears in the Data Storage window.

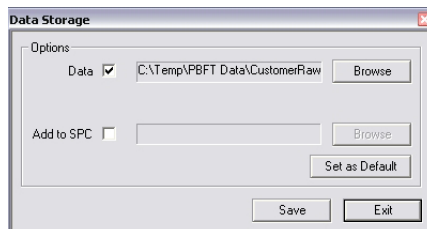

3. If desired, set the newly selected path as the default by clicking on the SET AS DEFAULT button in the Data Storage window. The next time the save function is activated, the default path will appear automatically in Data Storage.

**NOTE:** To prevent the default path from expiring when the current user logs out, make it permanent in the Data tab [[Account Manager - Data](#) (pg 61) and [Create Preset - Data](#) (pg 70)]. A permanent path setting saves all information for a user to the location defined for their data.

4. Repeats steps 2 and 3 if additional data storage options are to be used.
5. To assign a file name:
  - a. Click on SAVE in Data Storage. Save As appears. The default file name will appear in the following format:

MMDDhhmm

where MM is month, DD is day, hh is hour, and mm is minute. You may change the file name if you wish.

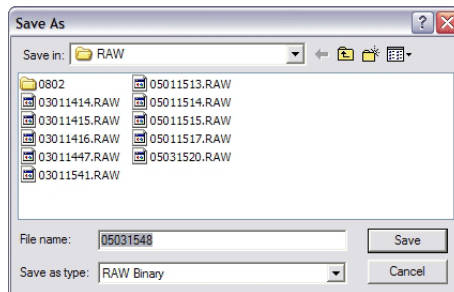

- b. To store the data, click SAVE in the Save As window. If multiple data storage options (Data, Add to SPC) are enabled, a Save As window will appear, in sequence, for each option.
6. To exit Data Storage, click EXIT.

## Print test results

SPC test results, with the exception of histograms, can be printed in graph and label formats. See examples in *Report & Label Samples*.

To print test results:

1. Click the PRINT RESULTS button in the PBFT Control Center window. A prompt about Print Results appears.

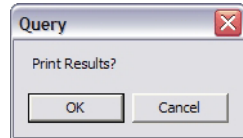

2. Choose one:
  - To print graph format, click OK.
  - To print ONLY label format, click CANCEL. This skips graph printing and a Print Labels prompt appears. Now click OK.

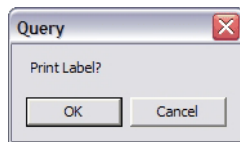

3. A standard print window appears (unless the Use Default Printer option has been selected in the Print tab of the Account Manager window). Select a printer, the number of copies, and click OK.

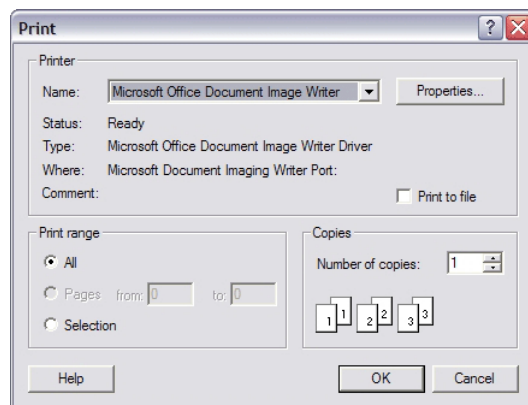

4. If you chose to print a graph in step 3, you will be prompted now to print a label. If you select OK, the same Print window as shown in the previous step will appear. Select the label printer and the number of desired labels, and then click OK.

## Change unit of force

As needed, you may change the unit of force and then save or print again.

To change the unit of force:

1. Click the UNIT OF FORCE button in the PBFT Control Center window. The Unit of Force window appears.



2. Select the desired unit.
3. Click ACCEPT. The Force and Vertical Increment indicators on the PBFT Control Center reflect the current unit of force. The same will be reflected on the printed graph as well.

## Load results

As needed, you may load the results for a single test run and then view its statistics, change the unit of force, print the results, and save the results.

To load test results:

1. Click the LOAD RESULTS button in the PBFT Control Center window. The Open window appears.

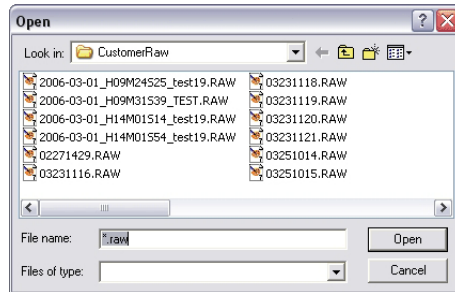

2. Select a single file and click OPEN. The data for the selected file will display as a graph in the PBFT Control Center. Also, the Active Preset field displays the name of the file, and all the peel test parameters from that test are loaded.

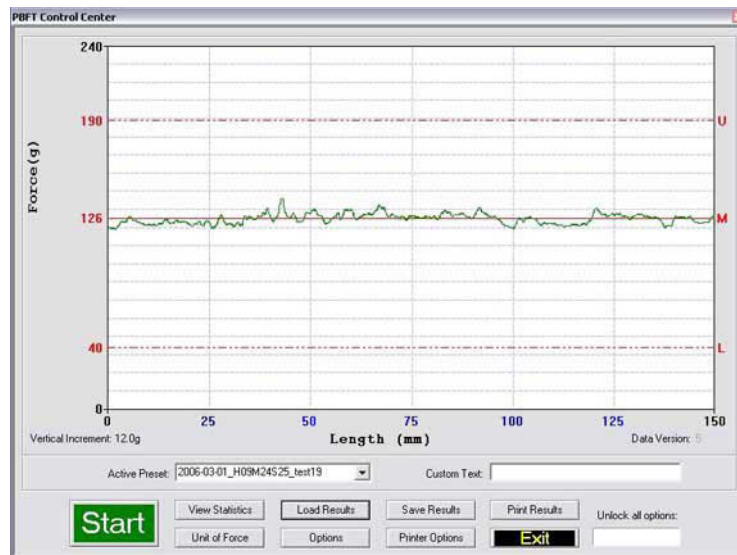

3. You may now act on this data using any of the PBFT Control Center buttons to which the currently selected user name has access rights.

## SPC analysis

As needed, process test results using SPC Analysis. SPC analysis basically consists of selecting the SPC files to be analyzed and then choosing the appropriate analysis tools. Analysis results may also be printed.

To select the appropriate files for analysis:

1. Click SPC > SPC Analysis in the main window menu bar. The Period Selection window appears.

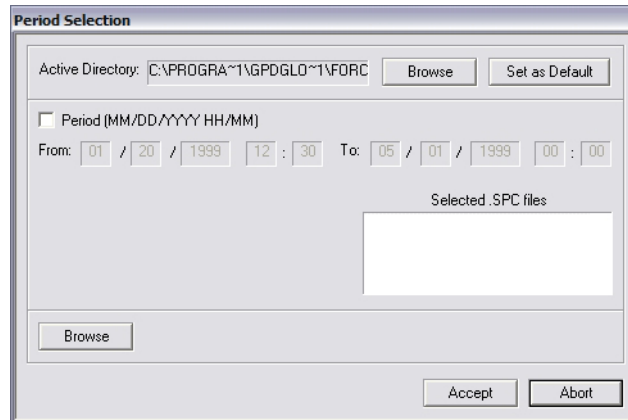

2. As needed, change the Active Directory:
  - a. Click on the BROWSE button to the right of the Active Directory field. A window similar to the following one appears.



- b. Locate and select the directory from which you wish to select files, then click OK. The selected path displays in the Active Directory field of the Period Selection window.
3. As needed, set the newly selected path as the default by clicking the SET AS DEFAULT button in the SPC Analysis window. The next time the SPC analysis function is activated, the default path will display automatically in SPC Analysis.

The default save directory for a specific user/vendor may also be specified in the Data tab of the Account manager window and the Create Preset window. This enables the user to log on as a vendor and obtain all of that vendor's information stored from a location specifically defined for their data.

4. Choose a method of SPC data selection based on either time or the active directory:

<p><b>METHOD A:</b> <b>Period of Time</b></p>	<p><b>METHOD B:</b> <b>Active Directory</b></p>
<p>To select test results from a user-defined date and time span:</p> <p>a. Enable the Period (MM/DD/YYYY HH/MM) check box.</p> <p>b. Enter dates and times as appropriate for the date and time span you want to include. As you change the values in the period selection fields, the panel containing file names will update.</p> <p>c. Go to step 5.</p>	<p>To select test results from the directory defined in the Active Directory field:</p> <p>a. Click the BROWSE button (lower left hand corner). Select SPC Files appears.</p> <p>b. Select as many files from this location as needed and click OPEN. The file names of the selected files will display in a panel in the Period Selection window.</p> <p><b>HINT:</b> Select a minimum of 5 files.</p> <p>c. Go to step 5.</p>

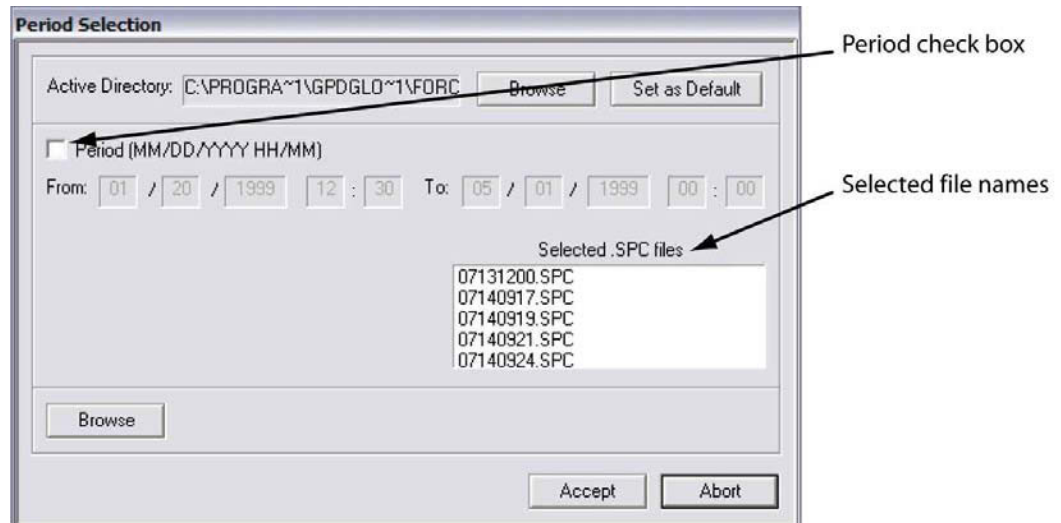

- Click ACCEPT. SPC Analysis appears displaying a graph of the selected file data.

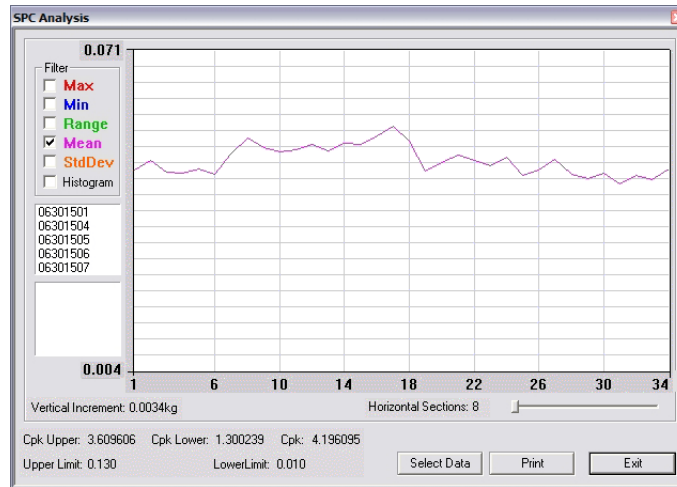

- As needed, analyze the data using the tools available in the SPC Analysis window. For details, refer to [SPC analysis tools](#) (pg 44).

For further details about each entity on the SPC Analysis window, refer to [SPC Analysis](#) (pg 82). For examples of available reports, refer to [Report & label samples](#) (pg 46).

- As needed, click PRINT to print the displayed data.
- As needed, click SELECT DATA to select a different set of files or a different date and time span. The Period Selection window will reappear.
- To exit SPC Analysis, click EXIT.



## Cpk on single tests

A “per test” statistic that calculates the Cpk of all recorded individual test points (graphed data) is available when the access option is enabled for the user in the account manager. When enabled, a “Cpk ST” value will display with other test results. Additionally, the Cpk value may be printed on labels and reports.

To calculate a Cpk value for an individual test run:

1. Enable Cpk calculation:
  - a. Go to the main menu bar, click on Setup > Configure Accounts. Account Manager appears.
  - b. Click on the Access tab.
  - c. Move the “Cpk Single Test” option between the disabled and enabled lists by either double clicking on the option or selecting the option and clicking the appropriate arrow.
  - d. Click SAVE to save the settings.
2. Run a test per standard practices.

**NOTE:** The upper and lower specification limits used for the test run are also used in the calculation of the Cpk value.

## 9 - Shutdown

To exit and shutdown operations:

1. Exit the FORCEWare software by clicking EXIT in the main menu bar of the main window, and then clicking OK on the resulting prompt.
2. Power off the strain gauge by pressing the strain gauge OFF button.
3. Power off the PBFT by turning off the power switch.
4. Power off the computer and, as applicable, the printer.

# Advanced operations

---

- [Presets](#) (pg 43)
- [SPC analysis tools](#) (pg 44)
- [Report & label samples](#) (pg 46)
- [User access](#) (pg 49)
- [Disabling live update](#) (pg 53)
- [Language selection](#) (pg 54)

## Presets

Presets are used to easily and quickly select a specific set of parameters for a test run. For example, once set up, a preset is readily available any time a test needs to be run for a particular vendor or type of component.

Like a user name, each preset can be used to run a test with specific strain gauge and print settings, and can designate test results be automatically saved to a specific directory. Unlike a user name, however, a preset cannot be used to enable/disable access rights, nor does it encompass all printing options.

A preset is created by opening the Create Preset window from Setup > Configure Presets on the main window menu bar, and then saving print and data defaults to a preset name.

To run a test using a particular preset, the operator simply selects the preset from the Active Preset drop-down menu in the PBFT Control Center window. The menu includes all preset names plus the current user name. The peel test parameters and configuration setup for the selected preset will be applied to the test run as the preset settings override the settings of the currently logged in user.

**NOTE:** To cancel a selected preset in the PBFT Control Center window, select the user name from the drop-down menu instead.

# SPC analysis tools

## Filters

Select from one to five of the available filters or select any combination of filters. The filters selected determine the type of test data results displayed and printed.

*A single filter is selected in the top example; all filters are selected in the bottom example.*



Use filters to control the type of test data results displayed and printed

## Single file statistics

You may view the statistics for any file within a reporting group. Clicking on a single test in the list of test files will display the statistics for that file. Additionally, a heavy black vertical line in the graph indicates the location of the points for the selected test within the graph.

*Statistics are displayed for the test file selected in the file list. Points for the selected file are indicated in the graph by the vertical indicator line.*

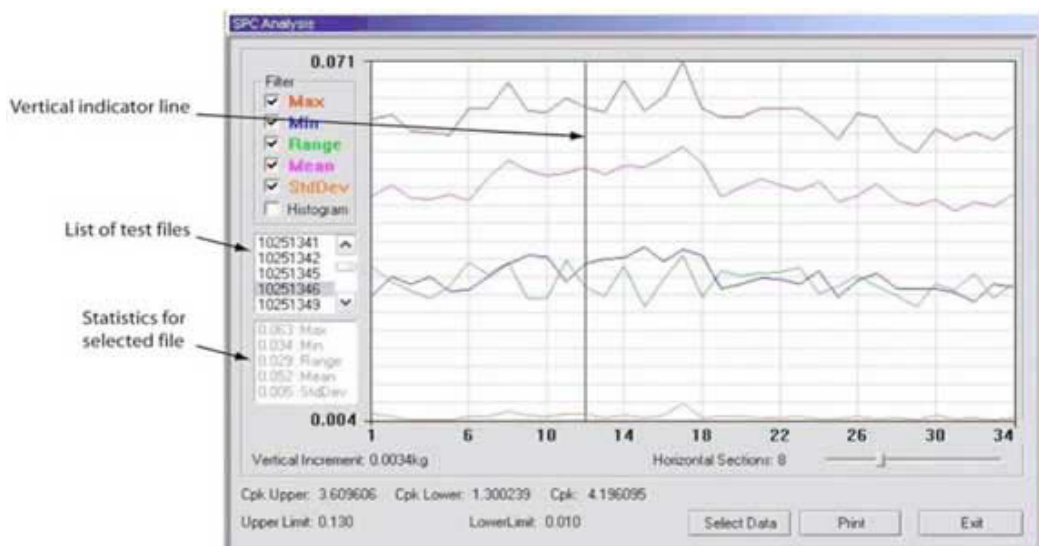

## Histogram

Select the Histogram check box to display a histogram in bar graph format. Any of the filters can be used one at a time with the Histogram.

*An example of a Histogram with the Mean filter selected.*



## Horizontal sections

You may change the number of horizontal sections in a histogram. Horizontal sections will adjust the range in a histogram or act as simply a visual indicator in line graphs.

*The number of horizontal sections selected affects the range displayed in a histogram.*

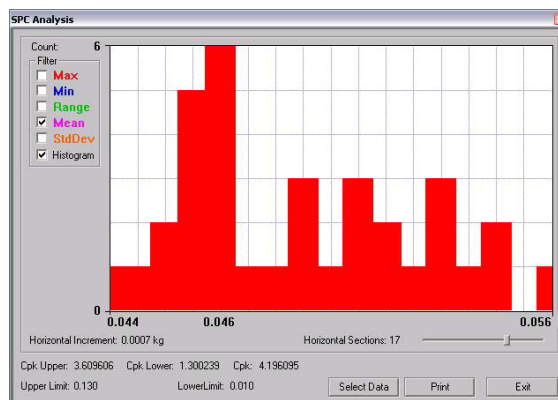

## Report & label samples

SPC test results can be printed in several different formats: SPC data, line graphs and labels. You may control the overall dimensions for all of these formats. You may also opt to have user-defined text print at the bottom of SPC data and line graphs reports.

**NOTE:** Histogram results can be displayed but not printed.

### Sizing

SPC data, graphs, and labels can be generated in a range of sizes, from full size down to 25% of full size. For details about how to change output scale, see [3 - Configure printer](#) (pg 23).

### Fixed text

User-defined, fixed text may be assigned to print at the bottom of SPC data and graphs. For details about how to add and modify fixed text, see [3 - Configure printer](#) (pg 23).

*Fixed text printed on test results report.*

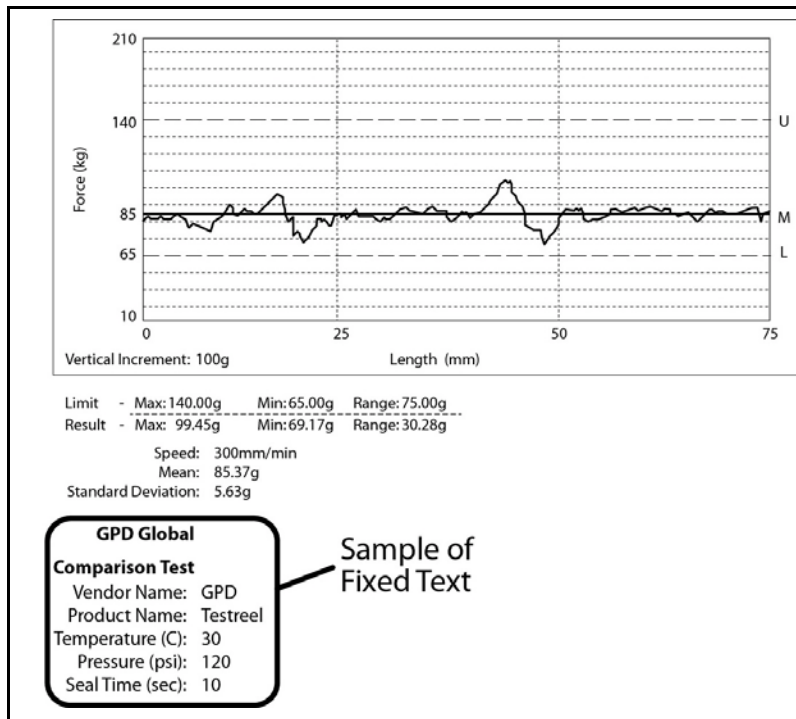

Fixed text printed on SPC line graph report.

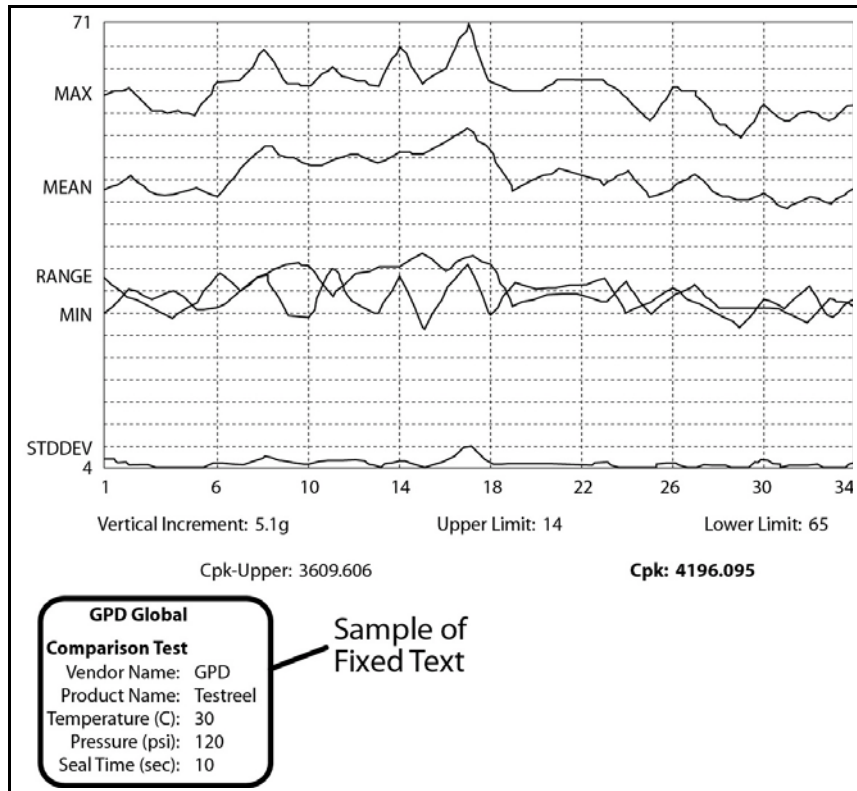

### Sample: line graph

Sample of single test line report generated through the PBFT Control Center.

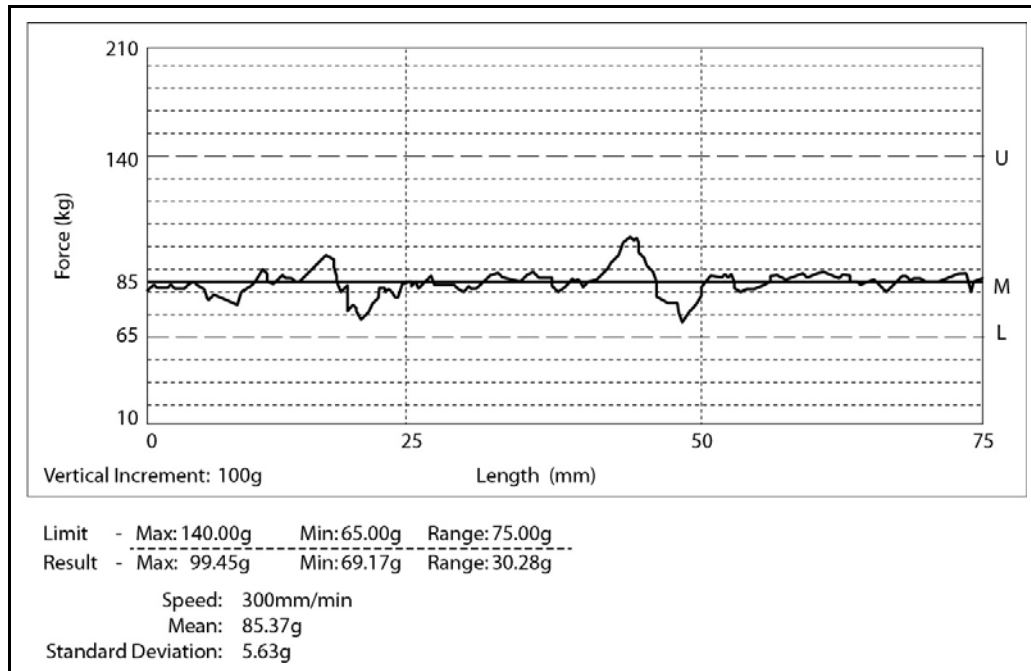



## Sample: SPC data graph

*Sample of printed label.*

April 14, 2011 - 11:00:07  
Mean:108.37g Range:114.29g SD:21.63g  
Lim:40.00/190.00g Resl:52.17/166.45g  
Len:150mm User:assembly

## User access

Use this section to create, change, or delete user accounts; and assign or change security levels, access rights, and passwords. You may also establish defaults for certain functions such as data storage, test parameters, and printer configuration options for users without access to those areas.

### Master user name & password

The master or highest *access level* User Name is **administrator**. The *password* for the master access level is determined by the user during the first login and can be changed later as needed.

To change the password for the administrator User Name:

1. Log on with the master access user name: *administrator*
2. From the main menu, click on Setup > Configure Accounts. Account Manager displays. (The RESET ADMINISTRATOR PASSWORD button is only available for the administrator user.)

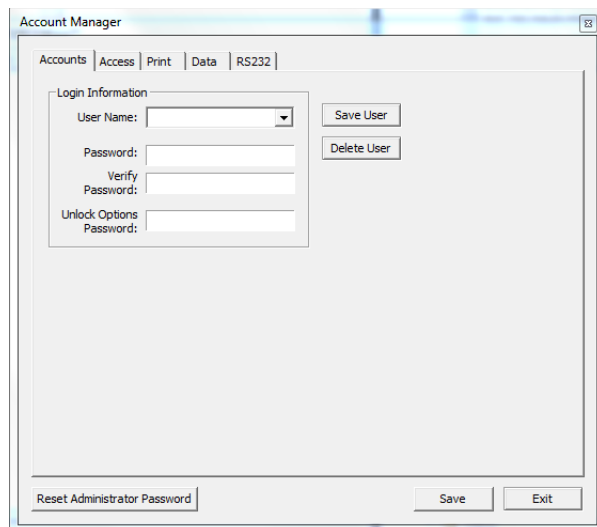

3. Click the RESET ADMINISTRATOR PASSWORD button. This button is available only for the administrator user. A prompt about resetting the administrator password displays.

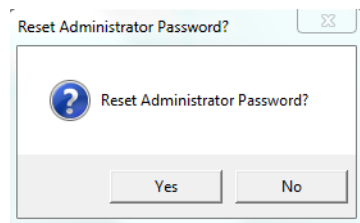

- If you want to reset the administrator (master) password, click YES; otherwise, cancel by clicking NO. The following prompt displays.

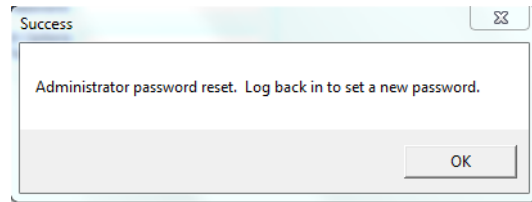

- Click OK and then log back in to enter a new password following the instructions for Step 1 of [6. Initial start up](#) (pg 12).

## Add user

To add a user account:

- Log on with a maximum access user name.
- From the main menu, click on Setup > Configure Accounts. Account Manager appears. Select the Accounts tab.

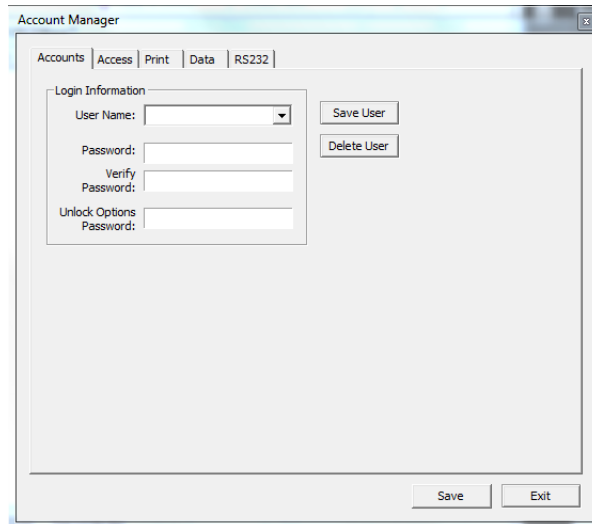

- Type a new name in User Name.
- Type a password in Password and Verify Password.
- Click on SAVE USER and then click OK on the prompt that appears.
- Set up access rights for the new user:
  - Click on the Access tab.
  - As needed, enable each default desired for this user account. Move a default option between the disabled and enabled lists by either double clicking on the option or selecting the option and clicking the appropriate arrow.
  - To save the settings, click on the Accounts tab and then click on SAVE USER.
- If additional user accounts need to be added, repeat steps 3 through 6. Multiple entries with the same access and default settings can be made easily as the settings remain until changed or a user account with different settings is selected.
- Click EXIT.

## Delete user

To delete a user account:

1. Log on with a Maximum security level user name.
2. From the main menu, click on Setup > Configure Accounts. Account Manager appears.
3. Select the user name to be deleted from the User Name pull down menu.
4. Click on DELETE USER and then click OK on the prompt that appears.
5. Click EXIT.

## Change access rights

To change the access rights for a user account:

1. Log on with a Maximum security level user name.
2. From the main menu, click on Setup > Configure Accounts. Account Manager appears.
3. Select the user name to be changed.
4. Change the access rights:
  - a. Click on the Access tab.

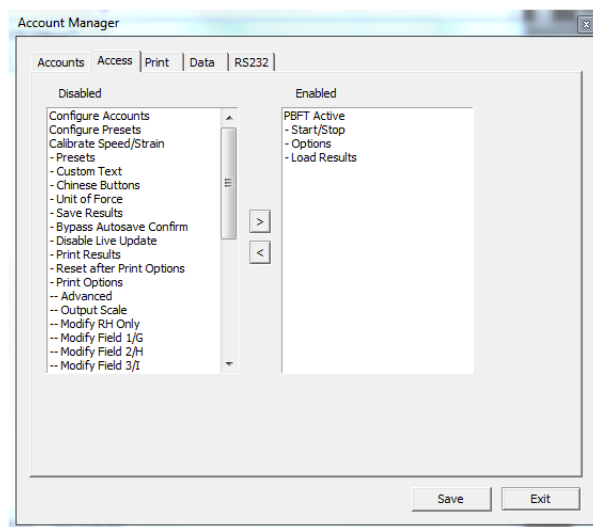

- b. As needed, enable each default desired for this user account. Move a default option between the disabled and enabled lists by either double clicking on the option or selecting the option and clicking the appropriate arrow.
  - c. To save the settings, click on the Accounts tab and then click on SAVE USER.
5. Repeat steps 3 through 4 as necessary to change access rights for additional user accounts. Multiple entries with the same access and default settings can be made easily as the settings remain until changed or a user account with different settings is selected.
6. Click Exit.

## Change password

To change a password for a user account:

1. Log on with a Maximum security level user name.
2. From the main menu, click on Setup > Configure Accounts. Account Manager appears.
3. Type a new password over the existing entry.
4. Type the new password again as a confirming entry in Verify Password.
5. Click on SAVE USER and then click OK.
6. Click EXIT.

## Disabling live update

Turning on the Disable Live Update feature prevents the test graph from displaying test results while the test is in process. Results are only displayed after the test is completed.

If the Disable Live Update feature is turned on when a test is run, a message similar to the following example displays for the duration of the test. The STOP button in the PBFT Control Center window is not affected; it remains active throughout the test. When the test is complete, the standard Test Results window will display.

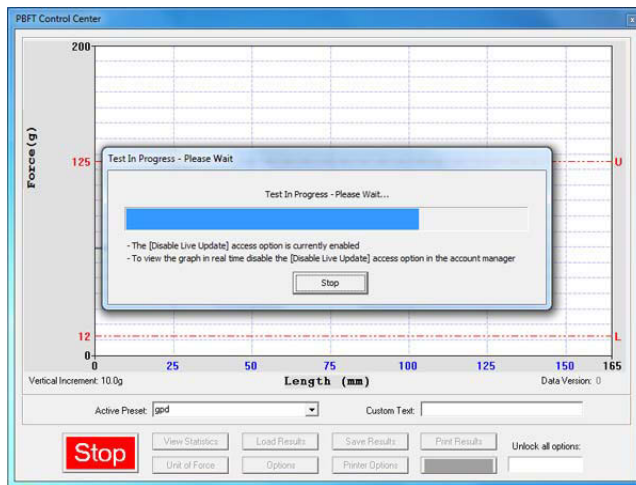

To turn on the Disable Live Update feature:

1. From the main menu bar, click Setup > Configure Accounts. The Account Manager - Access window displays.
2. Double-click on Disable Live Update to move it from the Disabled list to the Enabled list. A confirmation message displays.

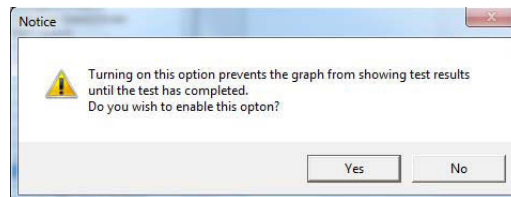

3. Click YES to turn on the Disable Live Update feature.
4. Click EXIT in the Account Manager - Access window. The Disable Live Update feature is now turned on (enabled).

## Language selection

The Start and Stop buttons used to initiate and abort test runs in the PBFT Control Center window can be displayed in Chinese and English or English only.

*START button displayed in Chinese/English*

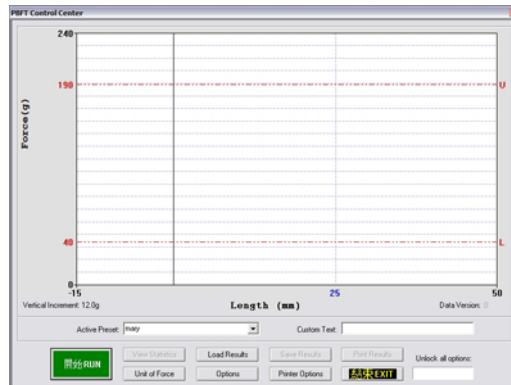

*STOP button displayed in Chinese/English*

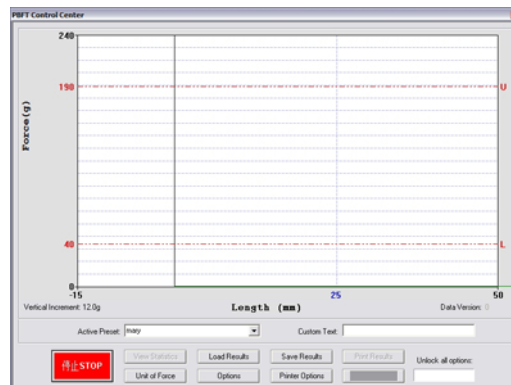

To change the language displayed:

1. Log on using a user account with access to the applicable access right (Chinese Buttons).
2. From the main menu, click on Setup > Configure Accounts. Account Manager appears.
3. In the Accounts tab, select the user name for which the displayed language is to be changed.

4. Change the access rights for Chinese Buttons:
  - a. Click on the Access tab.

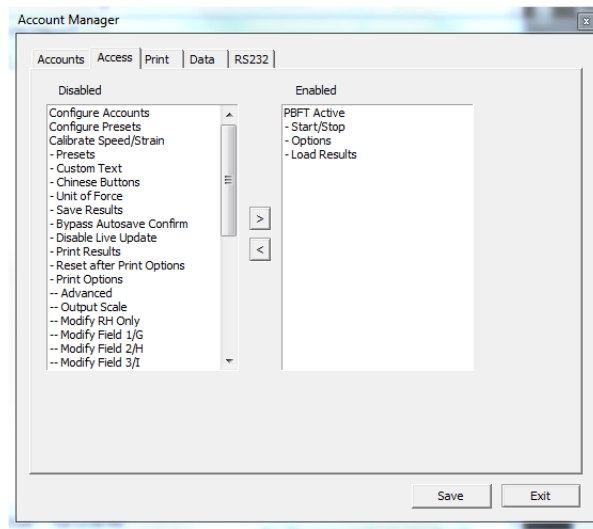

- b. Enable (or disable) the Chinese Buttons default for this user account. Move the default between the disabled and enabled lists by either double clicking on the option or selecting the option and clicking the appropriate arrow.
    - c. To save the settings, click on the Accounts tab and then click on SAVE.
5. Repeat steps 3 through 4 as necessary to repeat the access rights change for additional user accounts. Multiple entries with the same access and default settings can be made easily as the settings remain until changed or a user account with different settings is selected.
6. Click EXIT.



# Window references

---

A sample of each FORCEWare software window is included in this section with a detailed description of each element used in the window. Windows are presented in alphabetic title order.

- [About FORCEWare](#) (pg 57)
- [Account Manager - Access](#) (pg 58)
- [Account Manager - Accounts](#) (pg 60)
- [Account Manager - Data](#) (pg 61)
- [Account Manager - Print](#) (pg 63)
- [Account Manager - RS232](#) (pg 65)
- [Advanced Printer Configuration](#) (pg 66)
- [Calibrate Speed](#) (pg 68)
- [Calibrate Strain Gauge](#) (pg 69)
- [Create Preset - Data](#) (pg 70)
- [Create Preset - Presets](#) (pg 72)
- [Create Preset - Print](#) (pg 73)
- [Data Storage](#) (pg 75)
- [GPD FORCEWare](#) (pg 76)
- [Login](#) (pg 77)
- [PBFT Control Center](#) (pg 78)
- [Period Selection](#) (pg 80)
- [Printer Configuration](#) (pg 81)
- [SPC Analysis](#) (pg 82)
- [Test Parameter Options](#) (pg 84)
- [Test Results](#) (pg 85)
- [Unit of Force](#) (pg 86)
- [User Defined Fields](#) (pg 87)

## About FORCEWare

The About FORCEWare window describes the name, version, and release date of the software controlling the PBFT machine.

To open the About FORCEWare window, go to the main menu bar and click on About.

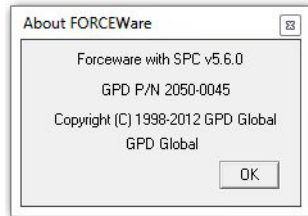

## Account Manager - Access

The Access tab of the Account Manager window enables any user with the Configure Accounts access right to assign any combination of access rights to any user name. Access rights can be moved from the disabled to enabled list, or vice versa, by either double-clicking the access right or selecting it and clicking the appropriate arrow.

To get to the Access tab of the Account Manager window, go to the main menu bar and click on Setup > Configure Accounts.

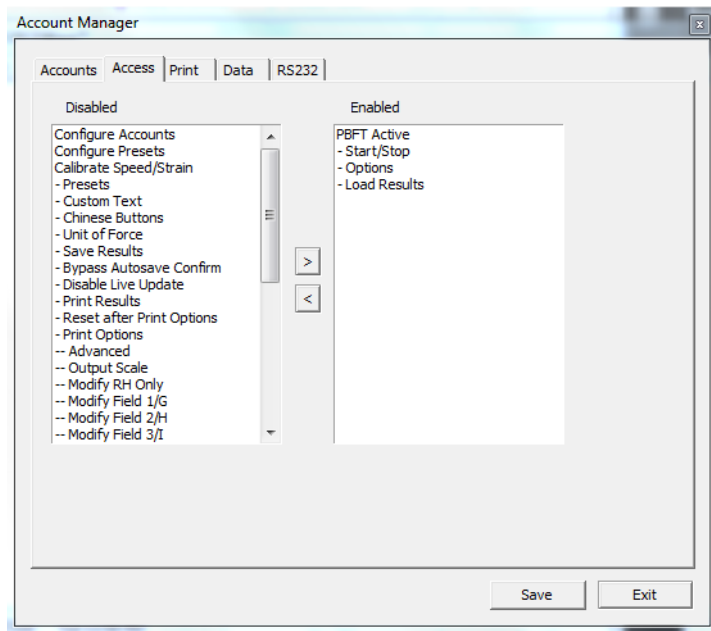

Element	Description
PBFT Active	Grants access to the PBFT Control Center window.
Start/Stop	Grants access to operating the Start/Stop button in PBFT Control window.
Options	Grants access to test parameter options via the Options button in the PBFT Control Center window.
Load Results	Grants access to the Load Results button in PBFT Control Center.
Configure Accounts	Grants access to create/modify/delete user login accounts.
Configure Presets	Grants access to create/modify/delete presets.
Calibrate Speed/Strain	Grants access to calibrating the PBFT speed dial and strain gauge.
Presets	Grants access to the preset selection window in the PBFT Control Center.
Custom Text	Grants access to the custom text window in the PBFT Control Center.
Chinese Buttons	Grants access to the display of the START/STOP and EXIT buttons in the PBFT Control Center window in both Chinese and English.
Unit of Force	Grants access to the Unit of Force button in PBFT Control Center.
Save Results	Grants access to the Save Results button in PBFT Control Center.
Bypass Autosave Confirm	Grants access to enabling the automatic saving of test results without user interaction.

Element	Description
Disable Live Update	Grants access to the delay of printing plotted data until after the run is complete (reducing the temptation to alter test results by manually pushing on the strain gauge during the run). For additional details, refer to <a href="#">Disabling live update</a> (pg 53).
Print Results	Grants access to the Print Results button in PBFT Control Center.
Reset after Print	Grants access to the resetting of test parameters on the PBFT Control Center window and the requirement that a new test be run each time values are changed in the Test Parameter Options window.
Print Options	Grants access to Printer Options.
Advanced	Grants access to and activates the Advanced button on the Printer Configuration window.
Output Scale	Grants access to control of the overall size of actual graph or label report dimensions. A range of 25% to 100% of full size is available.
Modify RH Only	Grants access to only the right hand column of text in the Print tab of both the Account Manger and Create Preset windows; the left hand column of text appears to be grayed out and becomes inaccessible.
Modify Field #/n	Grants access to modify Field 1/G through 19/Y which coordinate with User Defined G through Y on the Advanced Printer Configuration window, and the Print tab of both the Account Manager and Create Preset windows. These fields override the Modify RH Only setting.
SPC Analysis	Grants access to SPC Analysis and Period Selection.
Mean Text File Output	<p>When enabled, automatic and manual saves of test results generate an additional result file; a plain text file containing only the mean value of the test. This file is saved as the selected file name with "-mean" appended. When disabled, the above-mentioned file is no longer created with the other result files.</p> <p>Example: A test result save as file name "04261625" generates an additional file named "04261625-mean" with a ".txt" extension.</p>
Cpk Single Test	When enabled, calculation of Cpk value on individual test results is displayed along with other test results. The Cpk value can be printed on labels and reports. When disabled, the Cpk value is not available, displayed, or printed.

## Account Manager - Accounts

Use the Accounts tab of the Account Manager window to set up user names and associated passwords for access to the FORCEWare software program.

To access the Accounts tab of the Account Manager window, go to the main menu bar and click on Setup > Configure Accounts.

**NOTE:** Screen differences are indicated by dashed rectangles.

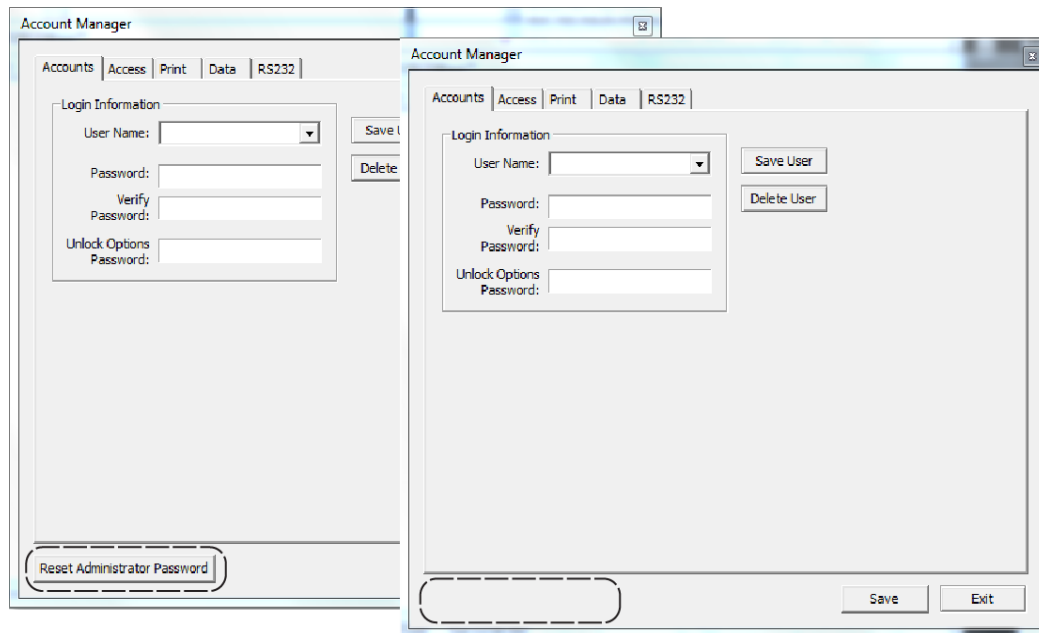

Element	Description
User Name	Can represent a user or a vendor. A user name may consist of 12 alphanumeric characters. Spaces are allowed. Any user name can have any combination of access rights assigned to it by means of a password.
Password Verify Password	Passwords are case sensitive and may consist of up to 12 alphanumeric characters. Spaces are allowed. A password is not revealed when typed; each character/space is displayed as a "*". A password is not required if you do not care about security. Requires a confirming entry in Verify Password.
Unlock Options Password	Defines the password that permits access to: <ul style="list-style-type: none"> <li>all buttons on the PBFT Control Center window.</li> <li>the Advanced button on the Print tab of the Account Manager window. The Advanced button opens the Advanced Printer Configuration window.)</li> </ul>
SAVE USER	Saves settings for the user account currently displayed in User Name.
DELETE USER	Deletes the user account currently displayed in User Name. A prompt displays to provide the opportunity to confirm that deletion should actually occur.
RESET ADMINISTRATOR PASSWORD	Displays only for the highest access level of User Name to allow the administrator to reset and/or modify the master password, i.e., the password for the administrator access level.

## Account Manager - Data

Use the Data tab of the Account Manager window to establish the default settings for data storage, data collection, and file name options.

To access the Data tab of the Account Manager window, go to the main menu bar and click on Setup > Configure Accounts and then select the Data tab.

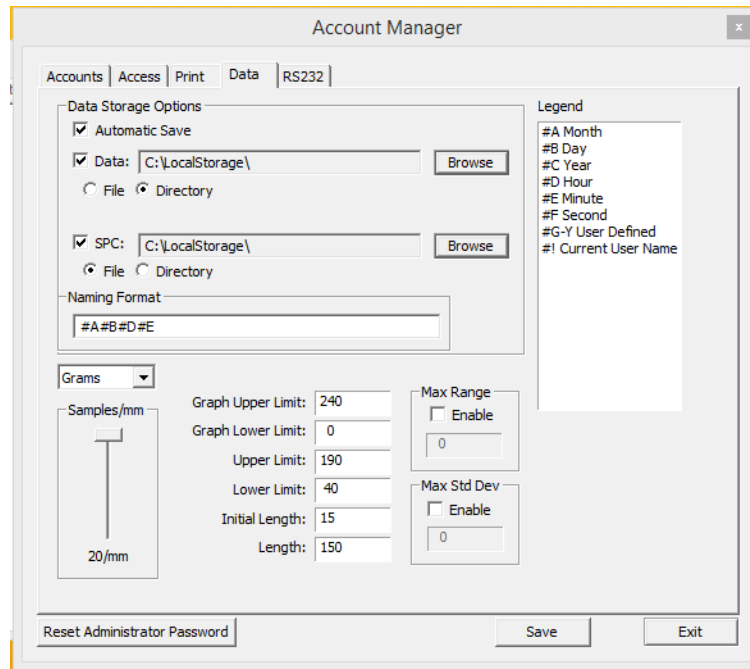

Element	Description
Automatic Save	These data storage options establish the defaults for data storage and printer configuration options unless overridden in the respective window by users with access to those areas. Depending on the location option (File or Directory) selected, file(s) are saved or a directory created to save peel back force tests:
Data	
SPC	
	<p><b>File</b></p> <p>If File is selected, files will be named per the Naming Format and saved into the Data or SPC directory specified. For example, files will be saved to "C:\LocalStorage\" (i.e., log file becomes "C:\LocalStorage\04201333.log")</p> <p><b>Directory</b></p> <p>If Directory is selected, files will be saved into a newly created (per test run) subdirectory named per the Naming Format and located within the Data or SPC directory. All file names using this option are named "results". For example, files will be saved to "C:\LocalStorage\04201333\" (i.e., log file becomes "C:\LocalStorage\04201333\results.log")</p>

Element	Description
Naming Format	<p>Defines the name of the file(s) saved or the directory created to save peel back force tests, depending on which location option (File or Directory) is selected. Backslashes can be used to create a custom directory structure.</p> <p><b>Examples:</b></p> <ul style="list-style-type: none"> <li>• If Naming Format is defined as #A-#B, a file would look something like 12-30.raw, and a directory would look something like "C:\LocalStorage\12-30\".</li> <li>• If Naming Format is defined as #A#B_Vendor24 #G (where the User Defined field G is set to BLUE), a file name would be similar to 1230_Vendor24 BLUE.raw, and a directory would be similar to "C:\LocalStorage\1230_Vendor24 BLUE\".</li> </ul> <p><b>Examples using backslashes:</b></p> <ul style="list-style-type: none"> <li>• Naming Format = #C\#A\#B\#D-#E-#F</li> <li>• Output file result with <b>File</b> option selected: C:\LocalStorage\2015\10\28\15-40-08.log</li> <li>• Output file result with <b>Directory</b> option selected: C:\LocalStorage\2015\10\28\15-40-08\results.log</li> </ul>
Legend	<p>A list of variables and the data they represent. Any time a Legend variable (#n) is typed in the Naming Format field, the data associated with that variable will be printed (rather than the "#n" representing the variable).</p>
Samples/mm slider Graph Upper Limit Graph Lower Limit Upper Limit Lower Limit Initial Length Length	<p>These data collection options establish the defaults for test parameter options unless overridden in the respective window by users with access to those areas.</p>
Max Range	<p>Fails a test if the pull value of the maximum-to-minimum range is greater than the defined amount.</p>
Max Std Dev	<p>Fails a test if the resulting Standard Deviation is greater than the defined amount.</p>
Reset Administrator Password	<p>Displays only for the highest access level of User Name to allow the administrator to reset and/or modify the master password, i.e., the password for the administrator access level.</p>

# Account Manager - Print

Use the Print tab of the Account Manager window to either establish the default settings for the printer configuration options, including report dimensions and appending report text, or opting to use print fields as a form to prompt the user for input before a test run.

To access the Print tab of the Account Manager window, go to the main menu bar and click on Setup > Configure Accounts.

**NOTE:** Screen differences are indicated by dashed rectangles.

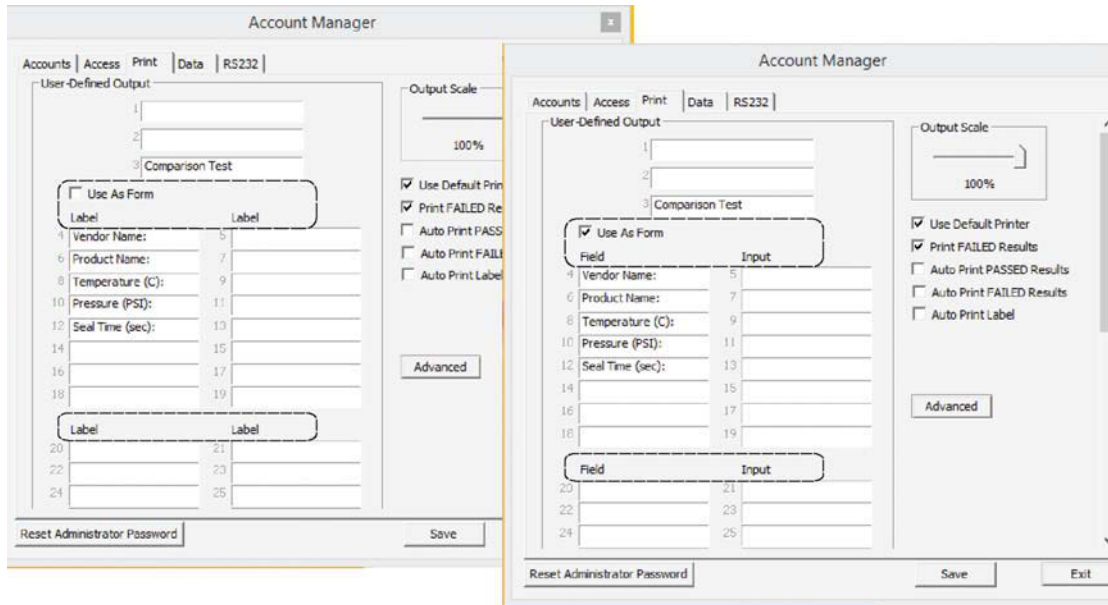

Element	Description
---------	-------------

User-Defined Output	<b>Layout of User-Defined Fields</b> - The key below illustrates how the user-defined fields are organized in the Print tab.
---------------------	--

**Key to User-Defined Field Layout**

User-Defined Output	
1/G	
2/H	
3/I	
4/J	5/K
6/L	7/M
8/N	9/O
10/P	11/Q
12/R	13/S
14/T	15/U
16/V	17/W
18/X	19/Y

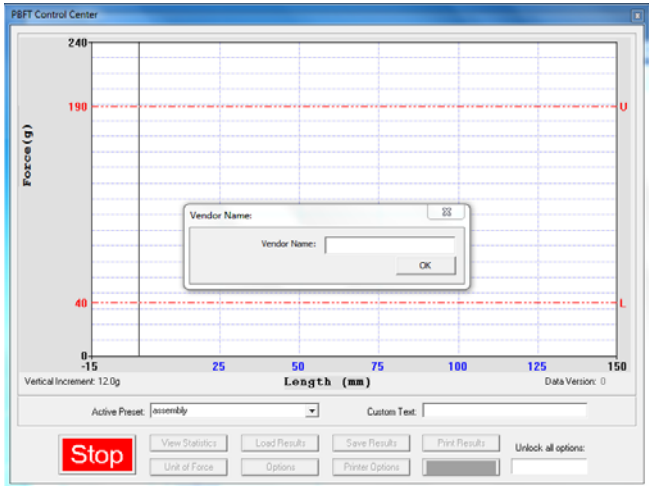

Element	Description
Use As Form	<p><b>Label / Label</b> - If "Use As Form" is disabled (not checked), the displayed column names switch to Label and Label, and all fields are simply text labels for printed documents or for naming format of data file output:</p> <ul style="list-style-type: none"> <li>The text from all filled-in user-defined fields will print at the bottom of all SPC data and graph reports.</li> <li>If a User-Defined Output field appears with a gray background rather than a white one, then access to that field is not permitted for the current user name.</li> </ul> <p><b>Field / Input</b> - If "Use As Form" is enabled (checked), then the displayed column names switch to Field and Input and allow the user to provide this data upon starting a test. The user will be prompted at the start of a test to provide a value for Input as long as Field contains some text and Input is empty.</p> <p>For example, if Use As Form is enabled, and Field contains "Vendor Name" text, and the corresponding Input field is empty, then the following prompt will display when a test is started.</p>
	
Output Scale	Controls the overall size of actual graph or label report dimensions. A range of 25% to 100% of full size is available.
Use Default Printer	Prints using the default settings, skipping the page setup and printer setup dialogs.
Print FAILED Results	<p>Grants access to manually printing any report whether failed or not. The default (unchecked) disallows printing of failed results.</p> <p>If set to default (unchecked) and Auto Print FAILED Results is checked, results from a <b>failed</b> test run will be automatically printed; however, the manual printing feature will not be allowed.</p>
Auto Print PASSED Results	Automatically prints test results only for successful tests in a graph format after a test has been run.
Auto Print FAILED Results	Automatically prints test results only for failed tests in a graph format after a test has been run. Also refer to Print FAILED Results.
Auto Print Label	Automatically prints test results in a label format after a test has been run.
ADVANCED	Opens the Advanced Printer Configuration window.

## Account Manager - RS232

Use the RS232 tab of the Account Manager window to set communication parameters. When the RS232 is enabled, test summary data is written to the serial port **at the same time the data is saved to files**.

Use the TEST button to verify your communication devices are working properly. A change to any configuration parameter is stored upon entry.

Data which is emitted on the serial port consist of the following: Mean, Maximum, Minimum, Standard Deviation, and Range. Values are space delimited and CR/LF terminated. Errors encountered on transmission via a serial connection are not reported.

To access the RS232 tab of the Account Manager window, go to the main menu bar and click on Setup > Configure Accounts.

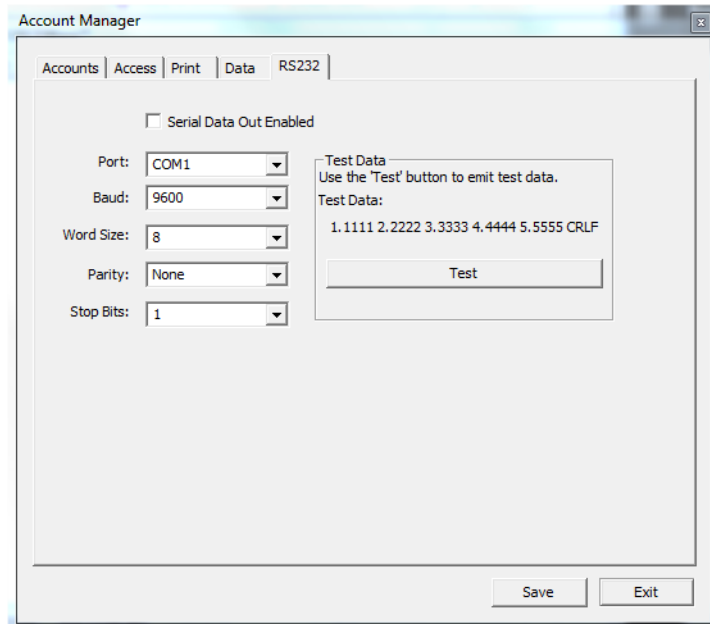

Element	Description
Serial Data out Enabled	Enables/Disables the RS232/emission of serial data. When checked, data will be output to the configured port.
Port Baud Word Size Stop bits	Standard RS232 parameters.
Test Data	The data string emitted when the TEST button is clicked.
TEST	Click to emit test data to verify your communication devices are working properly.

**NOTE:** All cabling and collection of data external to the PBFT RS232 serial port is the responsibility of the customer.

## Advanced Printer Configuration

Use the Advanced Printer Configuration window to customize the format of reports and/or labels by defining the content and the order in which the content will print on a report or label.

To open the Advanced Printer Configuration window, click on the ADVANCED button in the Print tab of Account Manager.

The screenshot shows the 'Advanced Printer Configuration' dialog box. It is divided into several sections:

- Results Format:** A text area containing:
 

```
Filename: #2
#1
#Z
Limit - Max:#5#0 Min:#6#0 Range:#7#0
-----
Result - Max:#8#0 Min:#9#0 Range:#A#0
Speed: #3mm/min
Mean: #B#0
```
- Label Format:** A text area containing:
 

```
#1
Mean:#B#0 Range:#A#0 SD:#C#0
Lim:#6/#5#0 Resl:#9/#8#0
Len:#4mm User:#E
```
- Results Fontsize:** An input box with the value '14'.
- Label Fontsize:** An input box with the value '28'.
- Text Spacing:** A vertical slider with 'Default' at the top and 'More' at the bottom.
- Legend:** A list of symbols and their corresponding field names:
  - #> New Page
  - #0 Unit
  - #1 Date
  - #2 Filename
  - #3 Speed
  - #4 Length
  - #5 Limit Max
  - #6 Limit Min
  - #7 Limit Range
  - #8 Result Max
  - #9 Result Min
  - #A Result Range
  - #B Mean
  - #C Std. Dev.
  - #D PASS/FAIL
  - #E Username
  - #F No. Samples
  - #G-Y User Def.
  - #Z Graph
  - #! Current User Name
  - #f1-#f35 User fields
- Buttons:** 'Clear All', 'Defaults', 'Accept', and 'Abort'.

Element	Description
Results Format	Any text entered here will print exactly as typed on a report.
Label Format	Any text entered here will print exactly as typed on a label.
Results Fontsize	Size of font used to print a report.
Label Fontsize	Size of font used to print a label.

Element	Description																						
Legend	<p>A list of variables and the data they represent. Any time a Legend variable (#n) is typed in the Results Format panel or the Label Format panel, the data associated with that variable will be printed (rather than the “#n” representing the variable).</p> <p><b>#! Current User Name</b> - user name of currently logged in user.</p> <p><b>#f1-#f35</b> - Key to User-Defined Field Layout</p>  <p>The image shows a dialog box titled "User-Defined Output". It contains a grid of 19 variables, each with a number and a letter. The variables are arranged as follows:</p> <table border="1"> <tr><td>1/G</td><td></td></tr> <tr><td>2/H</td><td></td></tr> <tr><td>3/I</td><td></td></tr> <tr><td>4/J</td><td>5/K</td></tr> <tr><td>6/L</td><td>7/M</td></tr> <tr><td>8/N</td><td>9/O</td></tr> <tr><td>10/P</td><td>11/Q</td></tr> <tr><td>12/R</td><td>13/S</td></tr> <tr><td>14/T</td><td>15/U</td></tr> <tr><td>16/V</td><td>17/W</td></tr> <tr><td>18/X</td><td>19/Y</td></tr> </table>	1/G		2/H		3/I		4/J	5/K	6/L	7/M	8/N	9/O	10/P	11/Q	12/R	13/S	14/T	15/U	16/V	17/W	18/X	19/Y
1/G																							
2/H																							
3/I																							
4/J	5/K																						
6/L	7/M																						
8/N	9/O																						
10/P	11/Q																						
12/R	13/S																						
14/T	15/U																						
16/V	17/W																						
18/X	19/Y																						
Text Spacing	<p>This slider controls the height of the space between the lines of text on the report and/or the label.</p>																						

## Calibrate Speed

Use Calibrate Speed to configure the PBFT speed indicator and verify that the simulated speed selector is synchronized with the mechanical speed dial on the PBFT.

**NOTE:** When a PBFT is equipped with a speed dial indicator range of 100 mm to 300 mm instead of 100 mm to 600 mm, the user should verify that the speed settings in the Calibrate Speed window match those of their hardware configuration. Details can be found under [2 - Verify PBFT speed](#) (pg 15).

To open Calibrate Speed window, go to main menu bar and click on Setup > Calibrate Speed.

*Example of 100-600 mm configuration.*

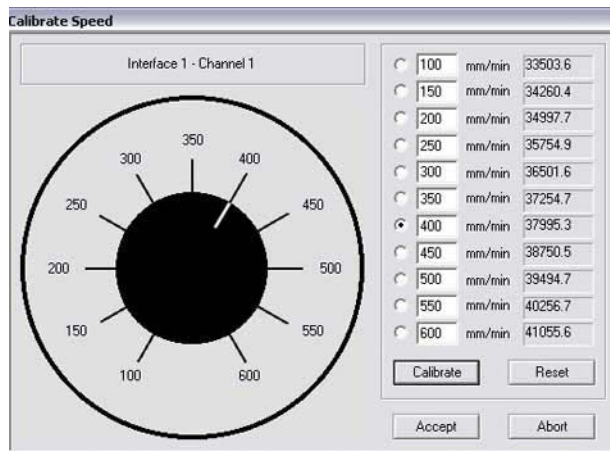

*Example of 100-300 mm configuration.*

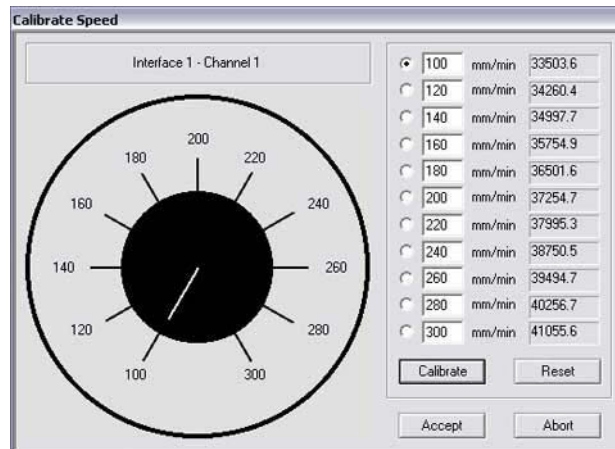

Element	Description
Speed Dial	Simulated speed selector used to calibrate the PBFT mechanical speed selector dial.
<i>nn</i> mm/min	Rate of peel speed in millimeters per minute. Values are in a raw data format for the PC interface card. A successful calibration will display values differing by a consistently similar number.
CALIBRATE	Executes calibration of the control software to the PBFT speed indicator.
RESET	Clears all mm/min fields.

## Calibrate Strain Gauge

Use the Calibrate Strain Gauge window to Verify the PBFT strain gauge.

To open the Calibrate Strain Gauge window, go to the main menu bar and click on Setup > Calibrate Strain Gauge.

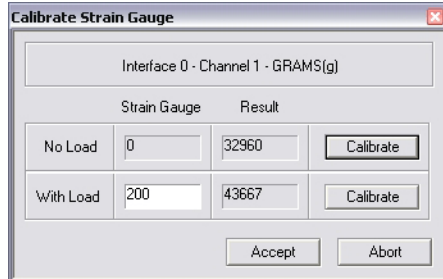

Element	Description
Interface - Channel	Indicates which PBFT strain gauge interface card and channel configuration is being verified. The unit of force currently in use also displays here.
Strain Gauge	
No Load	Display zero (0). With no load on the strain gauge, this integer value results from conversion of the strain gauge reading by the PC interface converter card.
With Load	Enter the value displayed on the strain gauge here. This value is converted into the "Result" column value when the Calibrate button is pressed.
Result	
No Load	Should display the verified zero load value for the strain gauge.
With Load	With a load on the strain gauge, this integer value results from conversion of the strain gauge load reading by the PC interface converter card.

## Create Preset - Data

Use the Data tab of the Create Preset window to establish data storage, data collection, and file name default settings for a particular preset.

To access the Data tab of the Create Preset window, go to the main menu bar and click on Setup > Configure Presets.

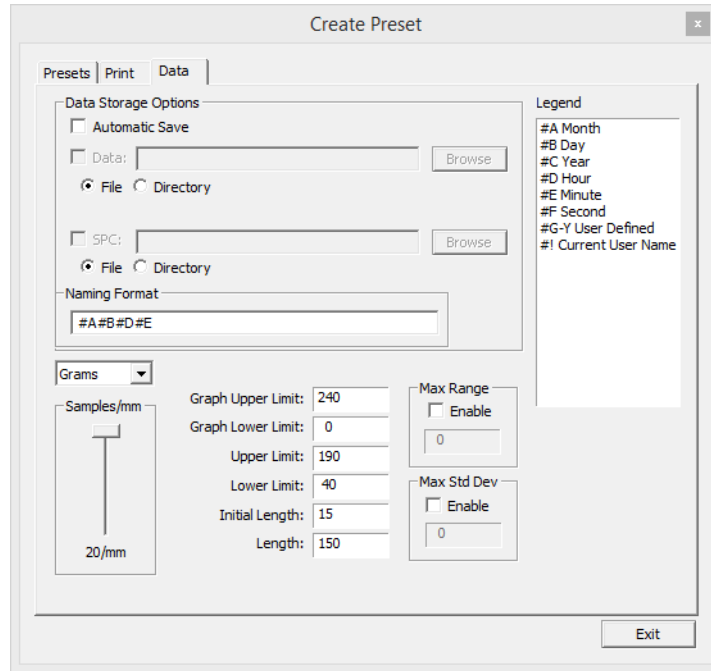

Element	Description
Automatic Save	These data storage options establish the defaults for data storage and printer configuration options unless overridden in the respective window by users with access to those areas. Depending on the location option (File or Directory) selected, file(s) are saved or a directory created to save peel back force tests:
Data	
SPC	
	<p><b>File</b></p> <p>If File is selected, files will be named per the Naming Format and saved into the Data or SPC directory specified. For example, files will be saved to "C:\LocalStorage\" (i.e., log file becomes "C:\LocalStorage\04201333.log")</p> <p><b>Directory</b></p> <p>If Directory is selected, files will be saved into a newly created (per test run) subdirectory named per the Naming Format and located within the Data or SPC directory. All file names using this option are named "results". For example, files will be saved to "C:\LocalStorage\04201333\" (i.e., log file becomes "C:\LocalStorage\04201333\results.log")</p>

Element	Description
Naming Format	<p>Defines the name of the file(s) saved or the directory created to save peel back force tests, depending on which location option (File or Directory) is selected. Backslashes can be used to create a custom directory structure.</p> <p>Examples:</p> <ul style="list-style-type: none"> <li>• If Naming Format is defined as #A-#B, a file would look something like 12-30.raw, and a directory would look something like "C:\LocalStorage\12-30\".</li> <li>• If Naming Format is defined as #A#B_Vendor24 #G (where the User Defined field G is set to BLUE), a file name would be similar to 1230_Vendor24 BLUE.raw, and a directory would be similar to "C:\LocalStorage\1230 Vendor24 BLUE\".</li> </ul> <p><b>Examples using backslashes:</b></p> <ul style="list-style-type: none"> <li>• Naming Format = #C\#A\#B\#D-#E-#F</li> <li>• Output file result with <b>File</b> option selected: C:\LocalStorage\2015\10\28\15-40-08.log</li> <li>• Output file result with <b>Directory</b> option selected: C:\LocalStorage\2015\10\28\15-40-08\results.log</li> </ul>
Samples/mm slider Graph Upper Limit Graph Lower Limit Upper Limit Lower Limit Initial Length Length	These data collection options establish the defaults for test parameter options unless overridden in the respective window by users with access to those areas.
Max Range	Fails a test if the pull value of the maximum-to-minimum range is greater than the defined amount.
Max Std Dev	Fails a test if the resulting Standard Deviation is greater than the defined amount.
Legend	A list of variables and the data they represent. Any time a Legend variable (#n) is typed in the Naming Format field, the data associated with that variable will be printed (rather than the "#n" representing the variable).



## Create Preset - Presets

Use the Presets tab of the Create Preset window to create, name, and delete presets.

To access the Presets tab of the Create Preset window, go to the main menu bar and click on Setup > Configure Presets.

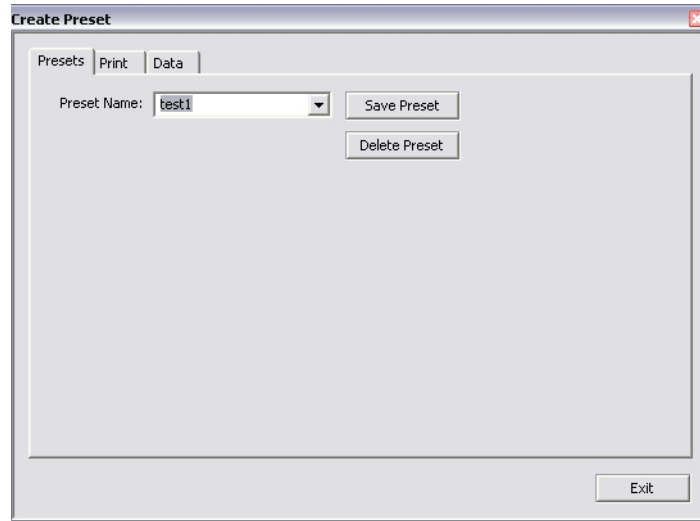

Element	Description
Preset Name	A set of pre-established parameters. Can be used, for example, to represent a vendor or type of component. A preset name may consist of 31 alphanumeric characters. Spaces are allowed.

## Create Preset - Print

Use the Print tab of the Create Preset window to either establish the default settings for appending report text for presets or opting to use print fields as a form to prompt the user for input before a test run.

To access the Print tab of the Create Preset window, go to the main menu bar and click on Setup > Configure Presets.

**NOTE:** Screen differences are indicated by dashed rectangles.

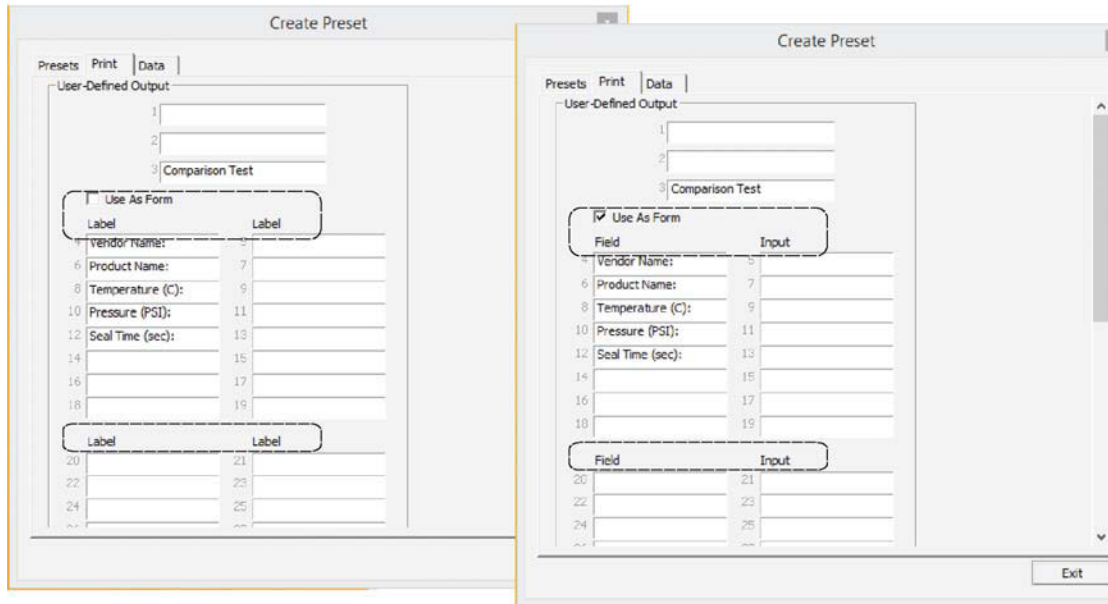

Element	Description
---------	-------------

**User-Defined Output** A User-Defined Output field may consist of 49 alphanumeric characters. Spaces are allowed.  
Layout of User-Defined Output fields - The key at right illustrates how the user-defined fields are organized in the Print tab.

User-Defined Output	
1/G	
2/H	
3/I	
4/J	5/K
6/L	7/M
8/N	9/O
10/P	11/Q
12/R	13/S
14/T	15/U
16/V	17/W
18/X	19/Y

---

Element	Description
Use As Form	<p><b>Label / Label</b> - If "Use As Form" is disabled (not checked), the displayed column names switch to Label and Label, and all fields are simply text labels for printed documents or for naming format of data file output:</p> <ul style="list-style-type: none"><li>• The text from all filled-in user-defined fields will print at the bottom of all SPC data and graph reports.</li><li>• If a User-Defined Output field appears with a gray background rather than a white one, then access to that field is not permitted for the current user name.</li></ul> <p><b>Field / Input</b> - If "Use As Form" is enabled (checked), then the displayed column names switch to Field and Input and allow the user to provide this data upon starting a test. The user will be prompted at the start of a test to provide a value for Input as long as Field contains some text and Input is empty.</p> <p>For example, if Use As Form is enabled, and Field contains "Vendor Name" text, and the corresponding Input field is empty, then the following prompt will display when a test is started.</p>

---

## Data Storage

Use the Data Storage options to establish the defaults for data storage. These defaults can be overridden from either the Account Manager window or the Create Preset window by users with access to those areas.

To open the Data Storage window, click on the SAVE RESULTS button in PBFT Control Center.

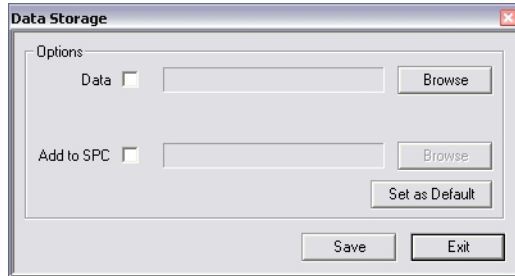

Element	Description
Data	Saves test results in raw data format.
Add to SPC	Saves test results in SPC format.
BROWSE	Designates the specific location to which file is to be saved.
SET AS DEFAULT	Temporarily designates save directory defaults for both Data and SPC files. When the user logs out, these defaults are lost.

## GPD FORCEWare

The GPD FORCEWare window is the main control window from which all software control is exercised.



Element	Pull-down Menu	Description
Setup	Configure Accounts	Create, modify, and delete user login accounts.
	Configure Presets	Create, modify, and delete presets.
	Calibrate Speed	Verify the PBFT speed dial.
	Calibrate Strain Gauge	Verify the PBFT strain gauge.
PBFT	Activate PBFT	Use PBFT Control Center to define test parameters and unit of measure, run a test, and view, print, and/or save test results. Also use this window to review prior test results.
SPC	SPC Analysis	Display and/or generate reports of SPC data for a user-defined group of test results over a user-defined date and time span.
Exit	---	Exits from the FORCEWare control software.
About	About FORCEWare	Title, version number, and release date of the control software.
User Name	---	A user name may consist of 12 alphanumeric characters. Spaces are allowed. Any user name can have any combination of access rights assigned to it by means of a password.
Password	---	Passwords are case sensitive and may consist of up to 12 alphanumeric characters. Spaces are allowed. A password is not revealed when typed; each character/space is displayed as a "*". A password is not required if you do not care about security.

## Login

Use the Login window to access the User Defined Fields window.

By entering their standard user name and password and pressing the LOGIN button, a user can open the User Defined Fields window and then edit various fields, as needed.

Without a valid user name and password, a user can still open the User Defined Fields window by pressing the LOGIN button, but this only gives them access to viewing the fields; no changes can be made.

To open the Login window, click on the USER FIELDS button in the Test Results window.

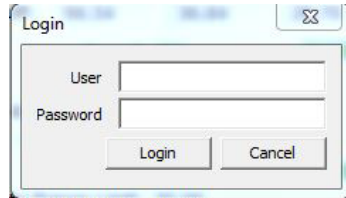

## PBFT Control Center

Use the PBFT Control Center window to define test parameters and unit of measure, run a test, and view, print, and/or save test results. Also use this window to review prior test results.

To open the PBFT Control Center window, go to the main menu bar and click on PBFT > Activate PBFT.

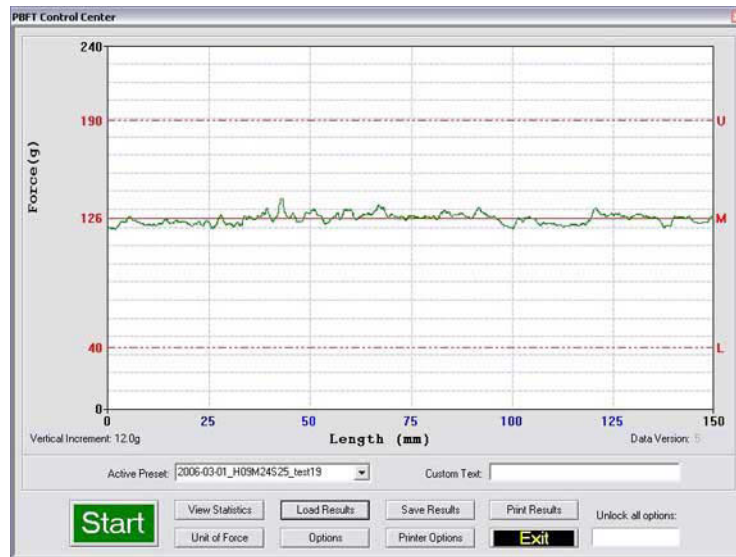

Element	Description
Force (kg or g)	Indicates the current unit of force used in the displayed graph and resulting test data.
Vertical Increment	Indicates the number of units per vertical bar (blue) in the current unit of force.
Length (mm)	Indicates in millimeters the length of the test.
Data Version	Version of FORCEWare under which the data was saved.
U	Maximum upper limit as defined in Test Parameter Options window.
M	The mean displays on the graph with a solid red line followed by an M after the test completes.
L	Minimum lower limit as defined in Test Parameter Options window.
Active Preset	The currently selected preset (or user name). Determines which set of parameters will be applied to the test run. Once set up, a preset is readily available any time a test needs to be run for a particular vendor or type of component.
Custom Text	Text entered here will replace User Defined Output field 19 on the Printer Configuration window when saved or printed.
Start/Stop	Enables control of test execution with the mouse or ENTER key. To initiate a test, click on the START button or press ENTER.
View Statistics	Displays the test results window. (Available only after a test has been run.)
Load Results	Loads a saved set of run data files to view or print.
Save Results	Saves active test results to a user-defined location. (Available only after a test has been run.)
Print Results	Prints test results in graph or label format. (Available only after a test has been run.)

<b>Element</b>	<b>Description</b>
Unit of Force	Defines the active unit of force. This unit of force measure may be changed at any time - before a run, after a run has been completed, or even for data loaded from a previous run.
Options	Defines test parameters.
Printer Options	Opens the Printer Configuration window.
Exit	Closes and resets the window.
Unlock all options	Entry here of the proper password grants access to all PBFT Control Center buttons. (Password is defined in the Unlock Buttons Password field on the Accounts tab of the Account Manager window.)



## Period Selection

Use the Period Selection window in conjunction with the SPC Analysis window to display and/or generate reports of SPC data for a user-defined group of test results over a user-defined date and time span.

To open the Period Selection window, go to the main menu bar and click on SPC > SPC Analysis.

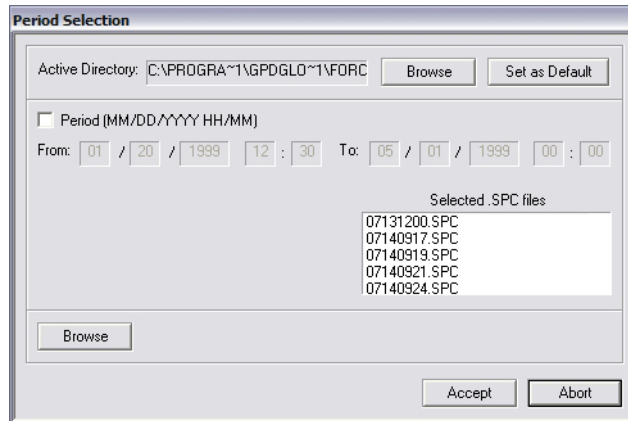

Element	Description
Active Directory	Displays the directory from which SPC files are to be selected. This directory is selected in the Data tab of the Account Manager or Create Preset windows.
BROWSE	Designates the specific location from which SPC files are to be selected.
SET AS DEFAULT	Designates the selection location for SPC files which are used in the SPC Analysis portion of the software.
Period	Designates the time span in “MM/DD/YY HH/MM” format over which SPC data is reported.
Selected .SPC Files	A minimum of 5 files is required to run SPC analysis. SPC files generated during the period of time designated by the specified dates and times.
BROWSE	Multiple file selections can be made using standard Windows file selection tools.

## Printer Configuration

Use the Printer Configuration window to establish defaults for the printer configuration options of report dimensions and appending report text. These defaults can be overridden from the Print tab of either the Account Manager window or the Create Preset window.

The background color (white or gray) of the User-Defined Output fields indicates whether or not the current user is permitted to change or delete text in these fields; a white background indicates the user has access, while a gray background indicates no access.

To access the Printer Configuration window, click on the PRINTER OPTIONS button in the PBFT Control Center window.

Element	Description
User-Defined Output	The text from all filled-in fields will print at the bottom of all SPC data and graph reports. If a User-Defined Output field appears with a gray background rather than a white one, then access to that field is not permitted for the current user name.  A User-Defined Output field may consist of 49 alphanumeric characters. Spaces are allowed.
Output Scale	Controls the overall size of actual graph or label report dimensions. A range of 25% to 100% of full size is available. The output scale will not display if the access right for this option is not enabled for the current user.
ADVANCED	Opens the Advanced Printer Configuration window. The output scale will not display if the access right for this option is not enabled for the current user.

# SPC Analysis

Use SPC Analysis in conjunction with the Period Selection window to display and/or generate reports of SPC data for a user-defined group of test results over a user-defined date and time span. (Histogram results may be displayed but not printed.)

To open the SPC Analysis window, click on the ACCEPT button in Period Selection.

All filter data displayed for selected data file.

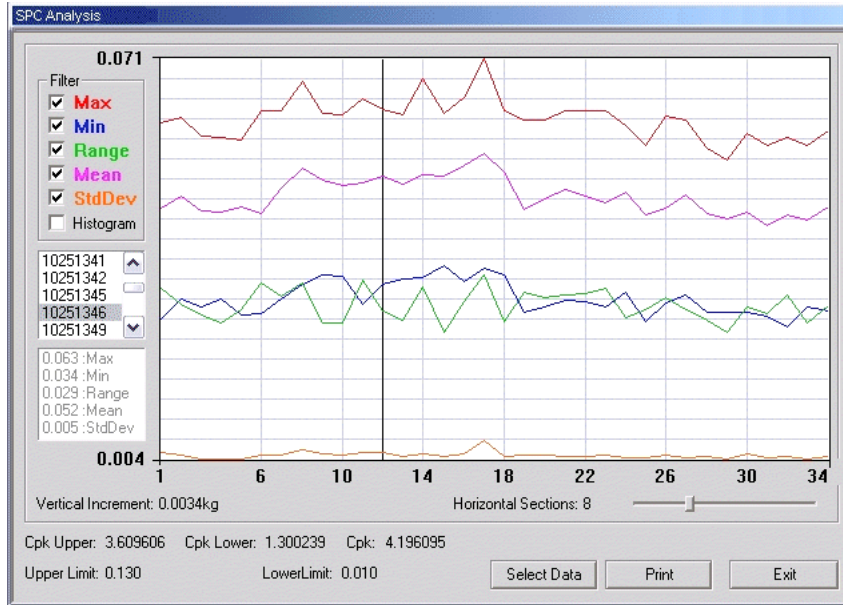

Histogram with Mean filter selected.

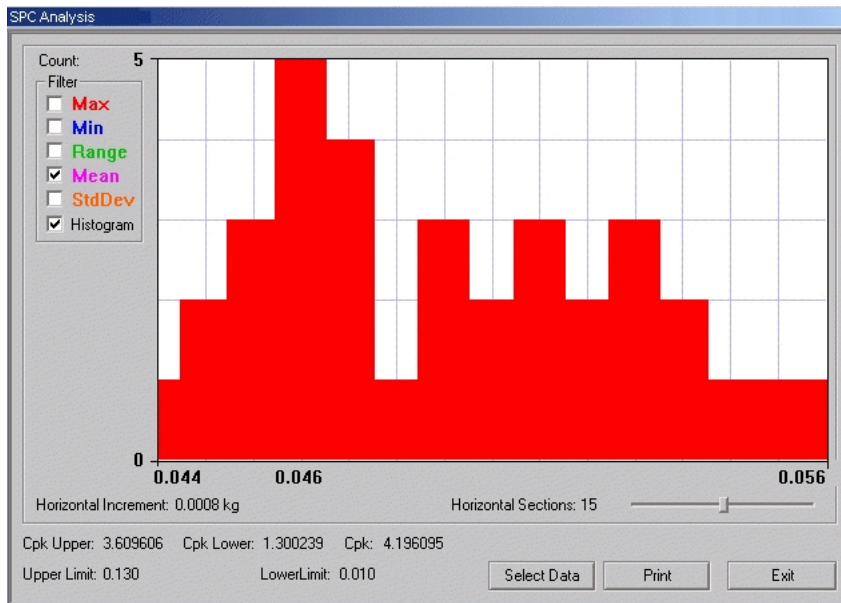

<b>Element</b>	<b>Description</b>
Count	For Histogram filter only. Number of occurrences a data point fell into the given range.
Filter	Determines the type of test data results displayed/printed.  <b>Max</b> - Maximum data point of all selected SPC files. <b>Min</b> - Minimum data point of all selected SPC files. <b>Range</b> - Difference between minimum and maximum data point. <b>Mean</b> - Mean data point of all selected SPC files. <b>StdDev</b> - Measure of dispersion in distribution beyond mean for all selected SPC files. <b>Histogram</b> - Uncovers non-normal behavior of the tests. Includes bar width for the histogram as computed by the program. The value can be changed to suit the user for a given analysis.
<i>list of files</i>	List of file names selected in Period Selection window.
<i>file data</i>	The SPC data of the selected file in the SPC Analysis window. As an example, notice the box of statistics for the 03011344 file selected in the window above at left.
Vertical Increment Horizontal Increment	Increment between the grid lines.
Horizontal Sections	Designates the number of horizontal sections displayed. Adjusts the range (Horizontal Increment) in histograms and acts as a visual reference in line graphs. Range is from 3 to 20 sections.
CpkUpper CpkLower Cpk	Cpk value of MAX reading from selected tests. Cpk value of MIN reading from selected tests. Cpk value of MEANS from selected tests.
Upper Limit Lower Limit	Maximum allowed upper and lower limits - synonymous with the upper and lower test limits on the graph display. These are taken from the first file selected in Period Selection.
SELECT DATA	Select the data to be analyzed by file location and date/time span.

## Test Parameter Options

Use the Test Parameter options to establish defaults for data storage, test parameters, and printer configuration options that will override those set up in the Data tab of both the Account Manager and Create Preset windows. Click the Set as Default button to write these changes to disk.

To open the Test Parameter Options window, click on the OPTIONS button in the PBFT Control Center window.

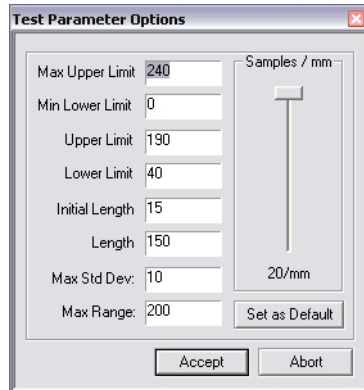

Element	Description
Max Upper Limit Min Lower Limit	Maximum and minimum values displayed on the graph. For screen display only, these values will not alter the actual data collected. If the data extends beyond the range of either the maximum or minimum limit, the data will be plotted on that extreme.
Upper Limit Lower Limit	Upper and lower threshold limits that determines whether a live run passes or fails. If the data extends beyond these limits, the software will fail the run.
Initial Length	Length of tape to be ignored while the material and data stabilize during the initial take-up. Default value for all tests run under the current user account.
Length	Actual length (in mm) of tape to be tested.
Max Std Dev	Fails a test if the resulting Standard Deviation is greater than the defined amount.
Max Range	Fails a test if the pull value of the maximum-to-minimum range is greater than the defined amount.
Samples/mm	Regulates the number of samples collected during every millimeter of a test. Ranges from 1 to 20 samples per millimeter. Slower computers may require a lower setting.
Set as Default	Sets the currently displayed values and Samples/mm setting as the defaults for all tests for the current user account.

# Test Results

Test Results quantifies test parameter results and displays whether or not the values were within the defined test parameters with PASSED or FAILED. To open the Test Results window, click on the VIEW STATISTICS button in the PBFT Control Center window.

*PASSED - successful test with MAX Range and/or Max Std Dev enabled and disabled.*

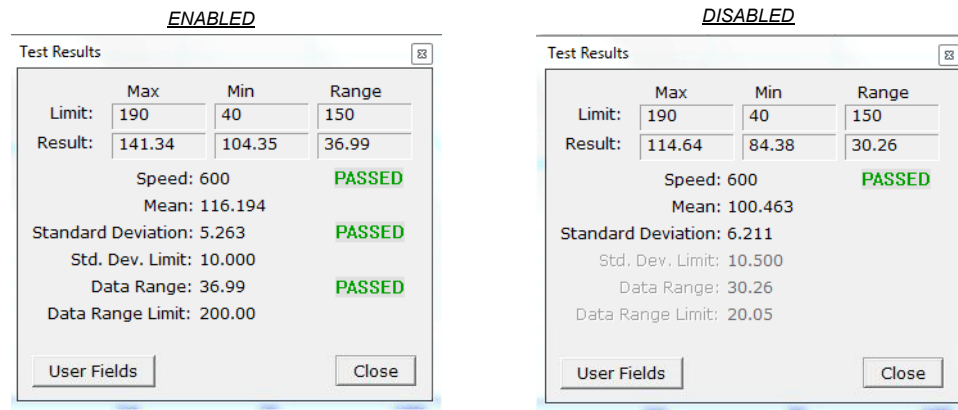

*FAILED - unsuccessful test with MAX Range and/or Max Std Dev enabled and disabled.*

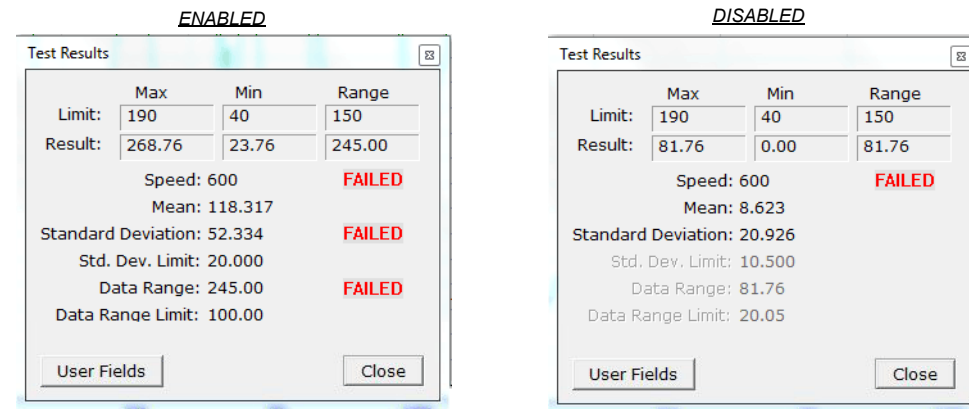

Element	Description
PASSED/FAILED	Result of test within the defined test parameters.
Limit	Maximum allowed. Test threshold limits in order to pass the test.
Result	Resulting test threshold limits.
Speed	Speed, in millimeters, at which the cover tape was peeled from the carrier tape during the test.
Mean	The average of the points collected.
Standard Deviation	The measure of dispersion in the distribution beyond the mean; the square root of the arithmetic average of the squares of the deviations from the mean.
USER FIELDS	Opens a prompt (Login window) for log in credentials. With credentials, the user can edit some of the fields in the User Defined Fields window; without credentials, only viewing of the User Defined Fields is allowed.

## Unit of Force

Use the Unit of Force window to establish the active unit of force.

To open the Unit of Force window, click on the UNIT OF FORCE button in PBFT Control Center.



---

Element	Description
Units	Recognized units of force: gram, kilogram, pound, newton. Designates the active unit of force. This unit of force measure may be changed at any time - before a run, after a run has been completed, or even for data loaded from a previous run.

---

## User Defined Fields

If errors were made while entering user-defined field and output data prior to running a test, the User Defined Fields window can be used to modify that data after the test is run (no statistical data can be modified). Test result data loaded from a saved file can be modified as well using this window.

If the applicable access permissions are set, all fields with a white background can be modified; if access has not been granted, all fields can be viewed but none can be edited (field background will appear gray). If the “Use as Form” option is enabled in the Account Manager window and the user filled in data prior to running a test, the data entered will be displayed in the User Defined Fields.

To open the User Defined Fields window, click on the LOGIN button in the Login window.

*Examples of permission status: access permitted (left) and read only (right).*

The image displays two side-by-side screenshots of the 'User Defined Fields' window. Both windows have a yellow title bar with the text 'User Defined Fields' and a red close button (X) on the right. The left window shows a form with a white background, indicating that the user has full edit access. The right window shows the same form with a gray background, indicating that the user has read-only access. The form contains several input fields, including a 'Comparison Test' field, and a list of fields: 'Vendor Name:', 'Product Name:', 'Temperature (C):', 'Pressure (PSI):', and 'Seal Time (sec):'. Each field has a corresponding input box. At the bottom right of each window is an 'OK' button.



# Maintenance



Follow these maintenance rules at all times:

#1 ONLY QUALIFIED MAINTENANCE OR TECHNICAL PERSONNEL fully aware of all safety precautions should perform preventive maintenance and troubleshooting procedures.

#2 READ ALL SAFETY NOTICES before proceeding.

#3 ALWAYS POWER OFF the PBFT and strain gauge before performing any maintenance.

## Preventive maintenance schedule

Although the PBFT is a delicate apparatus, it is a low maintenance piece of equipment. Basic maintenance considerations such as wiping dust from the unit's exterior with a soft clean cloth and covering it with a cloth cover during periods of non-use are the only maintenance steps necessary aside from the periodic ones listed.



**CAUTION:** Power off both the PBFT and the strain gauge before performing any maintenance.



**IMPORTANT:** Due to the main purpose of the PBFT – to take accurate measurements – it is strongly recommended that calibration be verified on a regular (at least monthly) basis.

Interval	Location	Action
Weekly	Machine Exterior	Clean exterior panels with soft dry cloth. Do not use liquid or aerosol cleaners.
	Control Buttons	Inspect button switches and lamps for burn out. Refer to Items 57, 58, and 60 on <a href="#">Mechanical assembly drawing - PBFTVS.USB700</a> (pg 103) and <a href="#">Exploded view - PBFTVS-USB700</a> (pg 104).  Replace if necessary. Refer to <a href="#">Replace lamp</a> (pg 89) procedure. To replace switch, see "Control button ineffective" symptom in <a href="#">Troubleshooting</a> (pg 96).
Monthly	Carriage Motor	Verify motor speed with <a href="#">Verify motor speed</a> (pg 89).
	Strain Gauge	Verify operations with <a href="#">Verify strain gauge operations</a> (pg 92).
Six Months	Set Screws	Remove PBFT cover and inspect all set screws and tighten if necessary. Refer to Item 39 on <a href="#">Mechanical assembly drawing - PBFTVS.USB700</a> (pg 103).
	Travel Shafts	Lubricate travel shafts (Item 73 on <a href="#">Mechanical assembly drawing - PBFTVS.USB700</a> (pg 103): 1 - Remove PBFT cover (Item 39 on <a href="#">Mechanical assembly drawing - PBFTVS.USB700</a> (pg 103). 2 - Clean the two travel shafts. 3 - Lubricate both shafts with a small drop of light machine oil so carriage moves smoothly.
	Gear Rack	Inspect gear rack and, if necessary, clean debris from teeth. Refer to Item 38 on <a href="#">Mechanical assembly drawing - PBFTVS.USB700</a> (pg 103).

## Replace lamp

To replace control button lamp [Item 60 on [Mechanical assembly drawing - PBFTVS.USB700](#) (pg 103)]:

1. Obtain new lamp. Refer to [Spare parts & accessories](#) (pg 99).
2. Pull off plastic button cover [Items 53, 54, or 56 on [Mechanical assembly drawing - PBFTVS.USB700](#) (pg 103)].
3. Twist and pull out old lamp. Then install new lamp and reinstall cover.

## Calibration accuracy

Motor speed and strain gauge operations are verified at the factory for accuracy of operations; however, if these need to be re-verified, re-calibrate per the following instructions.

### Verify motor speed

Use a stop watch when verifying motor speed.

1. Set speed selector to 100 mm.
2. Align tape carriage:

*Location of Tape Carriage and Length of Test Scale*

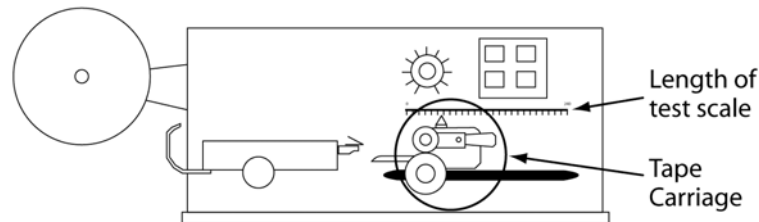

- a. Press CARRIAGE RELEASE/LOCK to release the tape carriage.
  - b. Align tape carriage's pointer at zero on Length of Test scale.
  - c. Press CARRIAGE RELEASE/LOCK again to lock the carriage in position.
3. Simultaneously, press TEST START and start your stop watch. When 60 seconds has elapsed, the pointer should be aligned with the 100 mm mark on the Length of Test scale.



**IMPORTANT:** If inaccurate alignment results, perform Motor Speed Re-calibration procedure.

4. Using the appropriate chart (600 or 300 mm/min), verify all motor speeds, re-calibrating as needed.

600 mm/min Model			300 mm/min Model		
To test this speed:	align pointer at:	when stop watch has timed:	To test this speed:	align pointer at:	when stop watch has timed:
100 mm	100 mm	60 seconds	100 mm	100 mm	60 seconds
150 mm	150 mm		120 mm	120 mm	
200 mm	100 mm	30 seconds	140 mm	140 mm	
250 mm	125 mm		160 mm	160 mm	
300 mm	150 mm		180 mm	180 mm	
350 mm	175 mm		200 mm	100 mm	
400 mm	100 mm	15 seconds	220 mm	110 mm	30 seconds
450 mm	150 mm	20 seconds	240 mm	120 mm	
500 mm	125 mm	15 seconds	260 mm	130 mm	
550 mm	110 mm	12 seconds	280 mm	140 mm	
600 mm	150 mm	15 seconds	300 mm	150 mm	

### Motor speed re-calibration

Re-calibrating motor speed consists of adjusting the voltage to the motor by varying the related trim pot.

To re-calibrate motor speed:

1. Remove the top cover from the PBFT and slide it back away from the front cover to expose the speed select board inside. The two outside rows of trim pots control motor speeds.
2. Set the PBFT speed selector to the speed to be calibrated.

3. Locate the correlating trim pot on the speed select board.

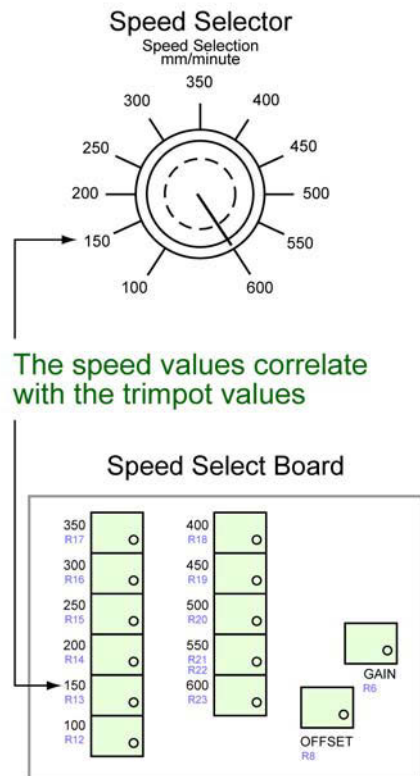

4. Adjust the trim pot by turning it **slightly**:
  - to *increase* speed, turn trim pot *clockwise*
  - to *decrease* speed, turn trim pot *counterclockwise*
5. Verify the new setting by repeating [Verify motor speed](#) (pg 89) instructions and repeating the above motor speed Re-calibration steps as necessary.

## Verify strain gauge operations

Use the following procedure to verify strain gauge operations. To install the Strain Gauge Calibration Kit (PBT-123), refer to [Installing calibration kit](#) (pg 95) instructions.

**⚠ IMPORTANT:** Re-calibration will be necessary if the strain gauge is replaced or repaired.

To verify strain gauge operations:

1. Turn the PBFT power switch on.
2. Press and hold the strain gauge power on/off button until a display appears.

**⚠ CAUTION:** DO NOT strike or jar the strain gauge. Apply pressure to the strain gauge clip in a pulling or pushing motion, not by hitting or jarring it. Applying force to this precision instrument at an excessive speed may result in permanent damage to the unit.

3. Verify the strain gauge is set to 'kg' units. If not, select 'kg' with the UNITS button ([Figure 3](#), Item 3) and then press the ZERO button ([Figure 3](#), Item 5) to reset the strain gauge to zero.
4. Slide the calibration kit's pulley extension arm onto the PBFT base plate (see below and [Figure 1](#), Item 9).

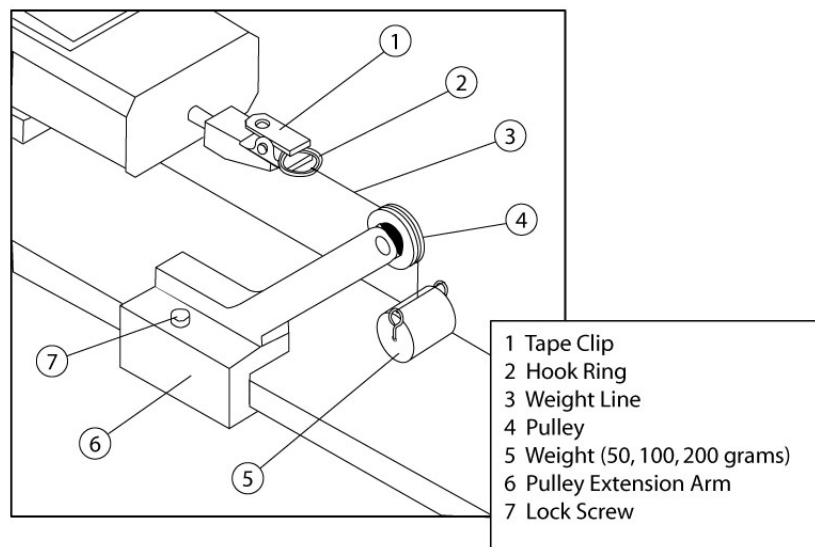

5. Position the arm so that a weight will hang.
6. Perform the [Verify strain gauge display & outputs](#) (pg 93) procedure.
7. Remove the calibration kit.

## Verify strain gauge display & outputs

Verify the strain gauge display and millivolt outputs:

**⚠ CAUTION:** DO NOT apply more than one (1) kilogram of force to the strain gauge clip. Applying excessive weight to this clip, which measures the peel back force of the cover tape, may result in permanent damage to the unit.

1. To verify that the strain gauge is performing in linear fashion, take voltage readings:
  - a. Disconnect the data output cable (see graphic below at left) from the strain gauge.
  - b. Take voltage reading across pins 11 and 12 (see graphic below at right).

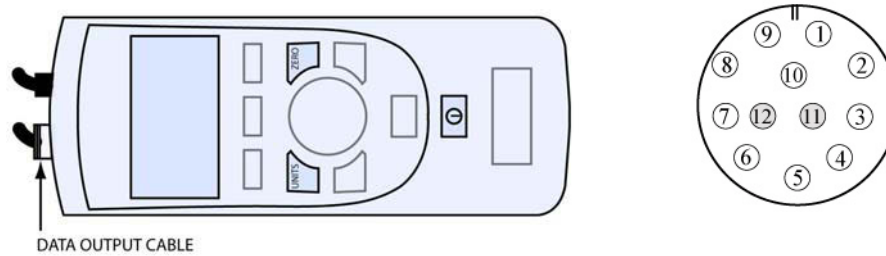

**Table 1: Connector Pin-out Assignments**

Pin	Symbol	I/O	Purpose	Description
1	TXD	O	RS-232	Transmitted Data
2	RXD	I	RS-232	Received Data
3	GND	O	Ground	Digital Ground
4		O	Clock	Mitutoyo Clock
5		O	Ready	Mitutoyo Ready
6		I	Request	Mitutoyo Request
7		O	Data	Mitutoyo Data
8		I	Detect	Sense Contact Closure
9		O	Setpoint	Setpoint Output Signal
10		-	Ground	Digital Ground
11		-	Analog GND	Analog Ground
12		O	Analog SIG	Analog Output

2. With zero (0) grams (no weight), the strain gauge should display 0.000 and measure less than 5 millivolts. Voltage measured at the connector on the side of the PBFT should be at or near zero (0) volts. Make note of this voltage and its polarity.

3. Verify the display and output with a 50 gram weight:

**NOTE:** PBFT Weight Declaration details are available here: [Weight declaration](#) (pg 101).

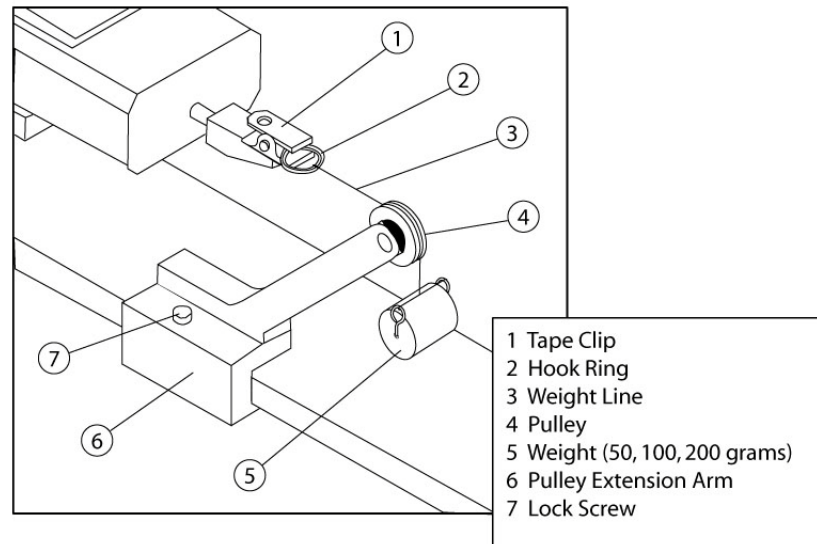

- a. Attach the 50 gram weight. The strain gauge should display 0.050 kilograms  $\pm$ .003 kg.

**CAUTION:** Support the weight while laying its line over the arm's pulley and clipping the hook ring in the tape clip.

**CAUTION:** GENTLY release the weight load onto the strain gauge.

- b. Measure the voltage and polarity.
- c. Subtract the voltage previously measured in step 6.b. Make note of the resulting new voltage which represents 50 grams.
- d. Remove the 50 gram weight.

4. Verify the display and output with a 100 gram weight:

- a. Attach 100 gram weight. The strain gauge should display 0.100  $\pm$ .005 kg.
- b. Measure the voltage and polarity.
- c. Subtract the voltage previously measured in step 6.b. Make note of the resulting new voltage which represents 100 grams and is twice the voltage of the 50 gram weight  $\pm$ .01 volts.
- d. Remove the 100 gram weight.

5. Verify the display and output with a 200 gram weight:

- a. Attach the 200 gram weight. The strain gauge should display 0.200  $\pm$ .010 kg.
- b. Measure the voltage and polarity.
- c. Subtract the voltage previously measured in step 6.b. Make note of the resulting new voltage which represents 200 grams and is twice the voltage of the 100 gram weight  $\pm$ .02 volts.
- d. Remove the 200 gram weight.

**IMPORTANT:** If verification results are unsatisfactory (if the readings are not within the aforementioned voltages, and if the strain gauge display values are not within the aforementioned grams), call the GPD Global Service Department

## Installing calibration kit

The calibration kit is a tool used to help verify strain gauge operations. To install the calibration kit on the PBFT:

1. Slide the kit pulley extension arm onto the PBFT base plate (see below and [Figure 1](#), Item 9).

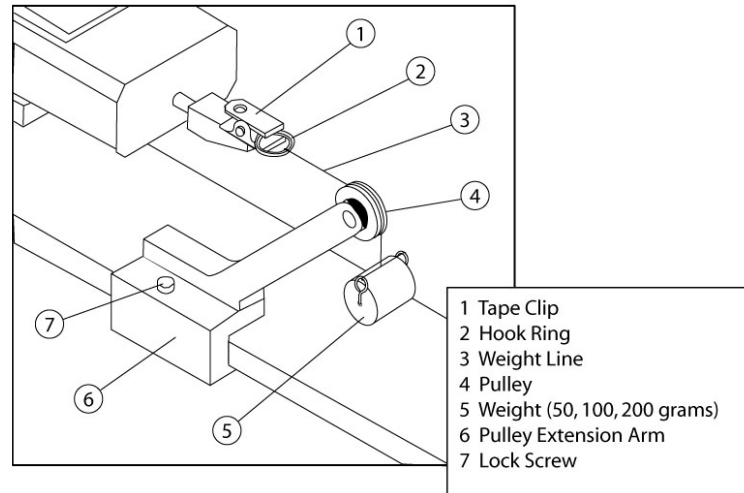

2. Position the arm so that a weight will hang.
3. Attach a weight (50, 100, or 200 grams):
  - a. Support the weight while laying its line over the pulley and clipping the hook ring in the tape clip.
  - b. GENTLY release the weight onto the strain gauge.
4. Verify the strain gauge displays the actual mass of the weight.



# Troubleshooting



**CAUTION:** ONLY QUALIFIED MAINTENANCE OR TECHNICAL PERSONNEL fully aware of all safety precautions should perform preventive maintenance and troubleshooting procedures.



**CAUTION:** Power off both the PBFT and strain gauge before performing any troubleshooting.

Symptom	Possible Cause	Action
Control button lamp not lighting.	Lamp is defective.	<p>Replace lamp [Item 60 on <a href="#">Mechanical assembly drawing - PBFTVS.USB700</a> (pg 103)]:</p> <ol style="list-style-type: none"> <li>1. Obtain new lamp. Refer to <a href="#">Spare parts &amp; accessories</a> (pg 99).</li> <li>2. Pull off plastic button cover [Items 53, 54, 55, or 56 on <a href="#">Mechanical assembly drawing - PBFTVS.USB700</a> (pg 103)].</li> <li>3. Twist and pull out old lamp.</li> <li>4. Install new lamp and reinstall cover.</li> </ol>
No power to the machine.	Input power module fuses are defective.	<p>Replace fuses [Item 66 on <a href="#">Mechanical assembly drawing - PBFTVS.USB700</a> (pg 103)]:</p> <ol style="list-style-type: none"> <li>1. Refer to <a href="#">Specifications</a> (pg 100).</li> <li>2. Obtain new fuse. Refer to <a href="#">Spare parts &amp; accessories</a> (pg 99).</li> <li>3. Remove fuse holder (Item 65).</li> <li>4. Replace defective fuses (Item 66)</li> <li>5. Return fuse holder to machine.</li> </ol>
	Power supply fuse is defective.	<p>First, inspect the input power module fuses (see prior <i>Possible Cause</i> in this table). If they are not faulty, inspect the fuse in the power supply [Item 15 on <a href="#">Mechanical assembly drawing - PBFTVS.USB700</a> (pg 103)]. Refer to <a href="#">Specifications</a> (pg 100). If the power supply fuse is defective, replace the power supply. When installing a new power supply, use the existing nylon screws and spacers in their original positions.</p>
Control button ineffective.	Control button switch is defective.	<p>Replace switch [Item 57 or 58 on <a href="#">Mechanical assembly drawing - PBFTVS.USB700</a> (pg 103)]:</p> <ol style="list-style-type: none"> <li>1. Obtain new switch. Refer to <a href="#">Spare parts &amp; accessories</a> (pg 99).</li> <li>2. Remove defective switch by removing PBFT cover [Item 39 on <a href="#">Mechanical assembly drawing - PBFTVS.USB700</a> (pg 103)]. Squeeze top and bottom clips at the base of the socket and pull socket base off the switch. Remove threaded switch retainer and washer. Pull switch lamp socket out from the front of the PBFT. De-solder and remove the defective switch.</li> <li>3. Install and solder a new switch base.</li> <li>4. Install switch lamp socket and replace PBFT cover.</li> </ol>

Symptom	Possible Cause	Action
Strain gauge display fails to appear or a message displays indicating charging is required.	Strain gauge battery pack is defective or spent.	<p>Inspect battery charging cable's (<a href="#">Figure 3</a>, Item 1) DC voltage:</p> <ul style="list-style-type: none"> <li>• If unequal to approximately 7 volts, replace the strain gauge charger. Refer to the instructions in the following row of this chart.</li> <li>• If approximately 7 volts with no load, replace the strain gauge battery. Refer to the following instructions.</li> </ul> <p><b>Replace Strain Gauge Battery</b> The battery should only need to be replaced if it causes the strain gauge to shut off.</p> <ul style="list-style-type: none"> <li>• The battery pack is internal to the strain gauge.</li> <li>• The strain gauge battery pack contains rechargeable NiMH (Nickel Metal Hydride) batteries. DO NOT replace with any other type of battery.</li> <li>• Battery pack is not accessible to the operator - it should only be replaced by qualified maintenance or technical personnel fully aware of all safety precautions.</li> </ul> <ol style="list-style-type: none"> <li>1. Remove the strain gauge from the PBFT by removing the two screws from the bottom of the strain gauge holding plate, unplugging the battery charging and data output cables, and then removing the strain gauge from the PBFT.</li> <li>2. Remove the lower half of the strain gauge case.</li> <li>3. Unplug the battery and replace it with a new battery pack.</li> <li>4. Reassemble the strain gauge and reinstall it on the PBFT.</li> </ol>
	Strain gauge charger is defective.	<p>Replace the strain gauge charger [Item 63 on <a href="#">Mechanical assembly drawing - PBFTVS.USB700</a> (pg 103)]:</p> <ol style="list-style-type: none"> <li>1. Remove the PBFT cover (Item 39).</li> <li>2. Remove the battery charger clamp (Item 27), the battery charger (Item 63) and its cables.</li> <li>3. Secure the new battery charger in place with the battery charger clamp and then reconnect the new cables.</li> <li>4. Secure the PBFT cover in place.</li> </ol>
Strain gauge display values do not coordinate with SPC software.	Strain gauge is defective.	1. If necessary, obtain new strain gauge.
	Strain gauge has been replaced or repaired.	<ol style="list-style-type: none"> <li>2. Perform steps 1 and 2 of <a href="#">2. Verify mechanical operations</a> (pg 6).</li> <li>3. Perform <a href="#">Verify strain gauge operations</a> (pg 92).</li> </ol>

## Uninstall FORCEWare software

### Supported software

---

To remove all FORCEWare data (all files created by installation and use of FORCEWare software) from the system:

1. In Windows, go to the Uninstall Programs feature.
2. Uninstall the program labeled InstaCal for Windows.
3. Uninstall the program labeled FORCEWare n.n.n.

### Unsupported software

---

**NOTE:** GPD Global no longer supports Windows XP and Vista software.

To remove all FORCEWare data (all files created by installation and use of FORCEWare software) from the system, uninstall the FORCEWare application and delete all files in the following directory.

The C: drive corresponds to the drive on which Windows is installed; this is typically the C drive.

- For Windows XP, files exist at this location:  
C:\Documents and Settings\All Users\Application Data\GPD Global\FORCEWare
- For Windows 8, 7, or Vista, files exist at this location:  
C:\ProgramData\GPD Global\FORCEWare

# Spare parts & accessories

---

## Suggested spare parts

Part Description	Part Number	Qty.
Fuse (power entry)	4300-0112	5
Lamp (control panel)	2450-0010	6
Latching Switch	5100-0009	1
Momentary Switch	5100-0010	1

## Suggested accessory

Part Description	Part Number
Calibration Kit	PBT-123

Kit contents:

- Pulley extension arm with pulley
- Weights (20, 50, 100, and 200 grams) each with a line and hook ring
- Nylon lock screw
- *Strain Gauge Calibration Verification Kit Instructions*



## Power

AC Input Voltage . . . . . 100 - 240 VAC  
AC Frequency . . . . . 50/60 Hz  
Consumption . . . . . 60 watts maximum  
Fuses, Input power module . . . . . 1 amp, 250 volts (F1A, 250 V)  
Fuse, Power supply . . . . . 2 amps, 250 volts (F2A, 250 V)

## Environmental

Operating Temperature Range . . . . . 40°F to 110°F (5°C to 45°C)  
Storage Temperature Range . . . . . 0°F to 130°F (-17°C to 54°C)  
Temperature Stability . . . . . 0.03% per °F  
Relative Humidity . . . . . 20% to 80%  
EMI, Radiated, 100-240 VAC Input EN 55011, Class A  
EMI, Conducted, 100-240 VAC Input EN 55011, Class A

## SPC software

Test Range:  
    SPC Analysis . . . . . User-defined range  
    Data Collection . . . . . Uses minimum/maximum limits of first file in selected data set.  
Print Options . . . . . SPC Data, Label Format, Line Graph Format

## Built-in compliance

IEC (Europe)  
EIA-J (Japan, Asia)  
EIA (North America) . . . . . EIA-481-1, EIA-481-2, EIA-481-3  
European CE Safety Standards  
    Applicable Directives . . . . . 2014/35/EU Low Voltage Directive (LVD) - Laws for electrical equipment within certain voltage limits.  
  
    2014/30/EU Electromagnetic Compatibility Directive (EMC) - Conformity is declared to Annex I and II (EMC) 2014/30/EU - Laws relating to electrical magnetic compatibility.  
  
    2006/42/EC Machine Directive - 1st Edition - December 2009 - Conformity is declared to Annex I and II (EMC) 2014/30/EU - Laws relating to machinery.  
  
    Applicable Standards . . . . . IEC 61010-1:2010+AMD1:2016 CSV  
    Safety requirements for electrical equipment for measurement, control, and laboratory use - Part 1:General requirements.

## Weight declaration

PBFT Weight Declaration issued by GPD Global:  
  
Equipment:  
    With standard strain gauge . . . . . Peel Back Force Tester  
    Strain Gauge Verification Kit  
    20, 50, 100, and 200 Gram Weights  
  
    With 250 gram strain gauge . . . . . Peel Back Force Tester  
    Strain Gauge Verification Kit  
    20, 50, 100, and 200 Gram Weights  
    Gauge Block  
  
Part Numbers . . . . . 200 gram Weight..... PBT-0507  
    100 gram Weight..... PBT-0506  
    50 gram Weight..... PBT-0505  
    20 gram Weight..... PBT-0589  
    Gauge block..... PBT-0590  
  
Declaration . . . . . All weights are within ±0.02% of nominal and NIST Class F traceable.

# References

---

## Drawings

- [Mechanical assembly drawing - PBFTVS.USB700](#) (pg 103)
- [Exploded view - PBFTVS-USB700](#) (pg 104)
- [Internal view - PBFTVS-USB700](#) (pg 105)

## Diagram

- [System block diagram - 00021-856-008](#) (pg 106)

## Schematics

- [Electrical schematic - 00021-856-002-06](#) (pg 107)
- [PCB schematic - 30002-856-002-01](#) (pg 108)

# Mechanical assembly drawing - PBFTVS.USB700

12/9/21

PBFT VS SPC User Guide

103

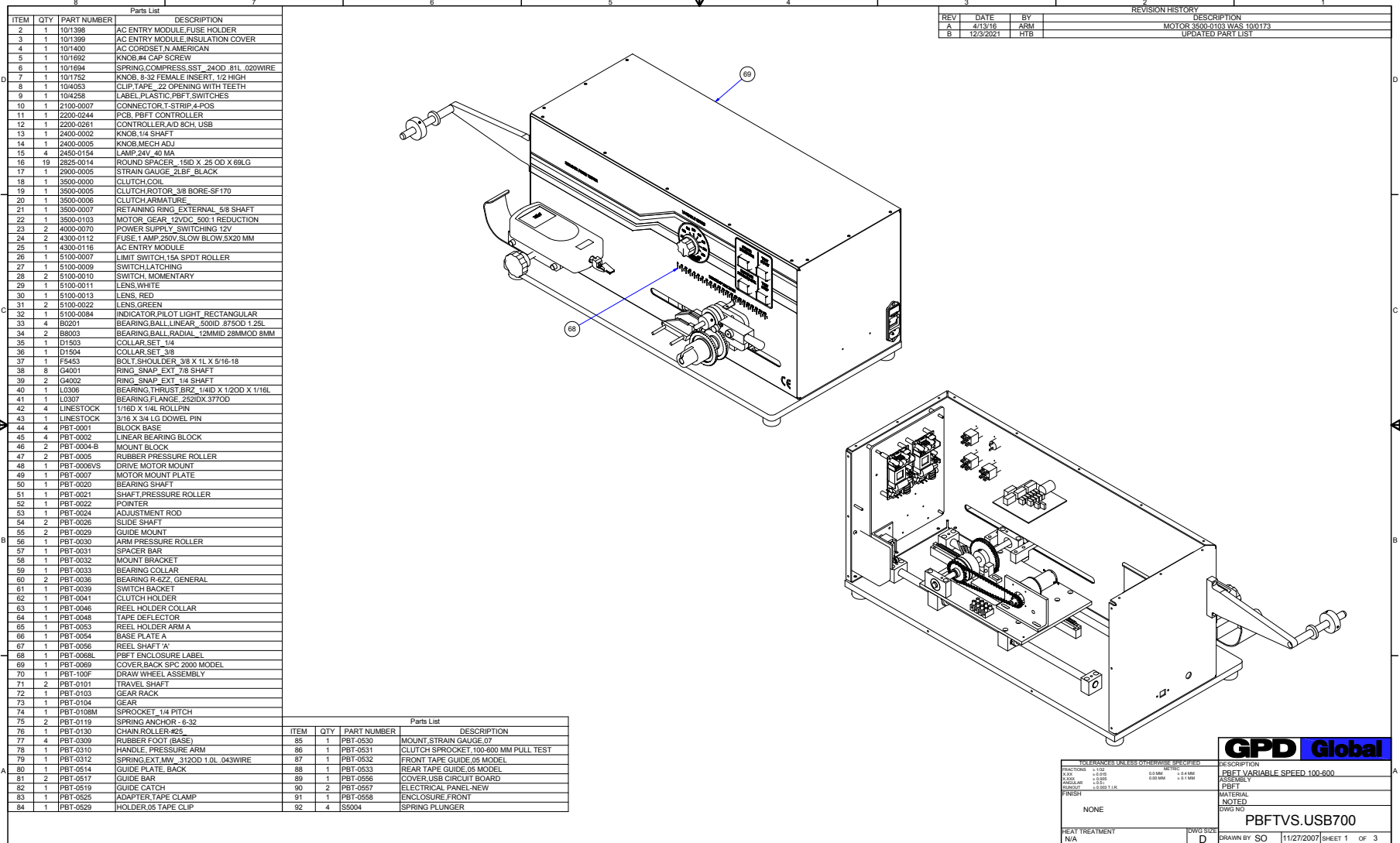



# Exploded view - PBFTVS-USB700

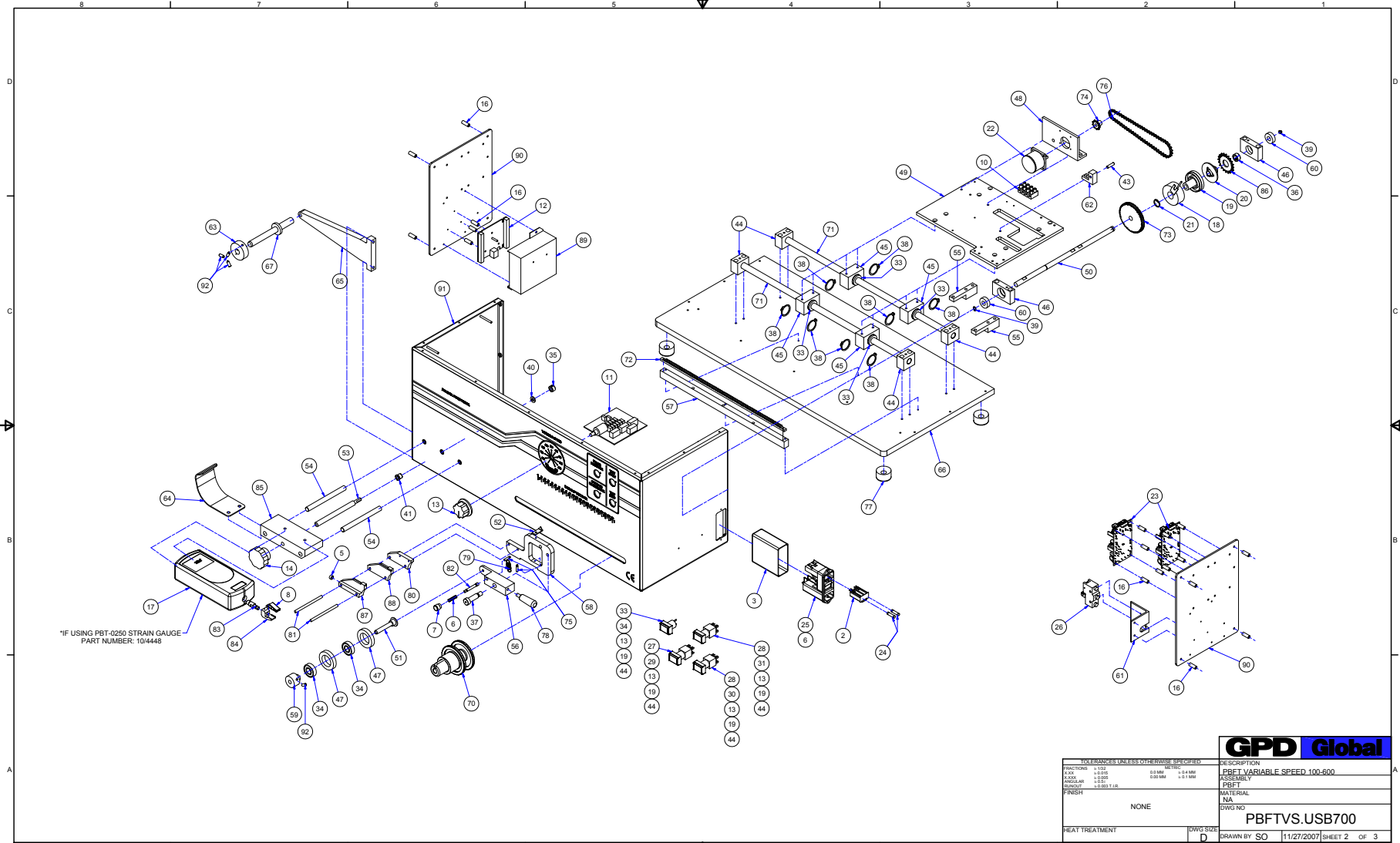

\*IF USING PBFT-0250 STRAIN GAUGE  
PART NUMBER: 104448

<b>GPD Global</b>	
TOLERANCES UNLESS OTHERWISE SPECIFIED	
FINISHING	AS SHOWN
FRACTION	1/16
DECIMAL	0.0005 0.001 0.002 0.005 0.010 0.020 0.050 0.100
ANGLE	0.0005 0.001 0.002 0.005 0.010 0.020 0.050 0.100
WELDING	AS SHOWN
PLATING	AS SHOWN
DESCRIPTION	PBFT VARIABLE SPEED 100-500
MATERIAL	POSSIBLY PBFT
DWG NO	N/A
DWG NO	PBFTVS.USB700
HEAT TREATMENT	NONE
DWG SIZE	D
DRAWN BY	SO
DATE	11/27/2007
SHEET	2
OF	3

# Internal view - PBFTVS-USB700

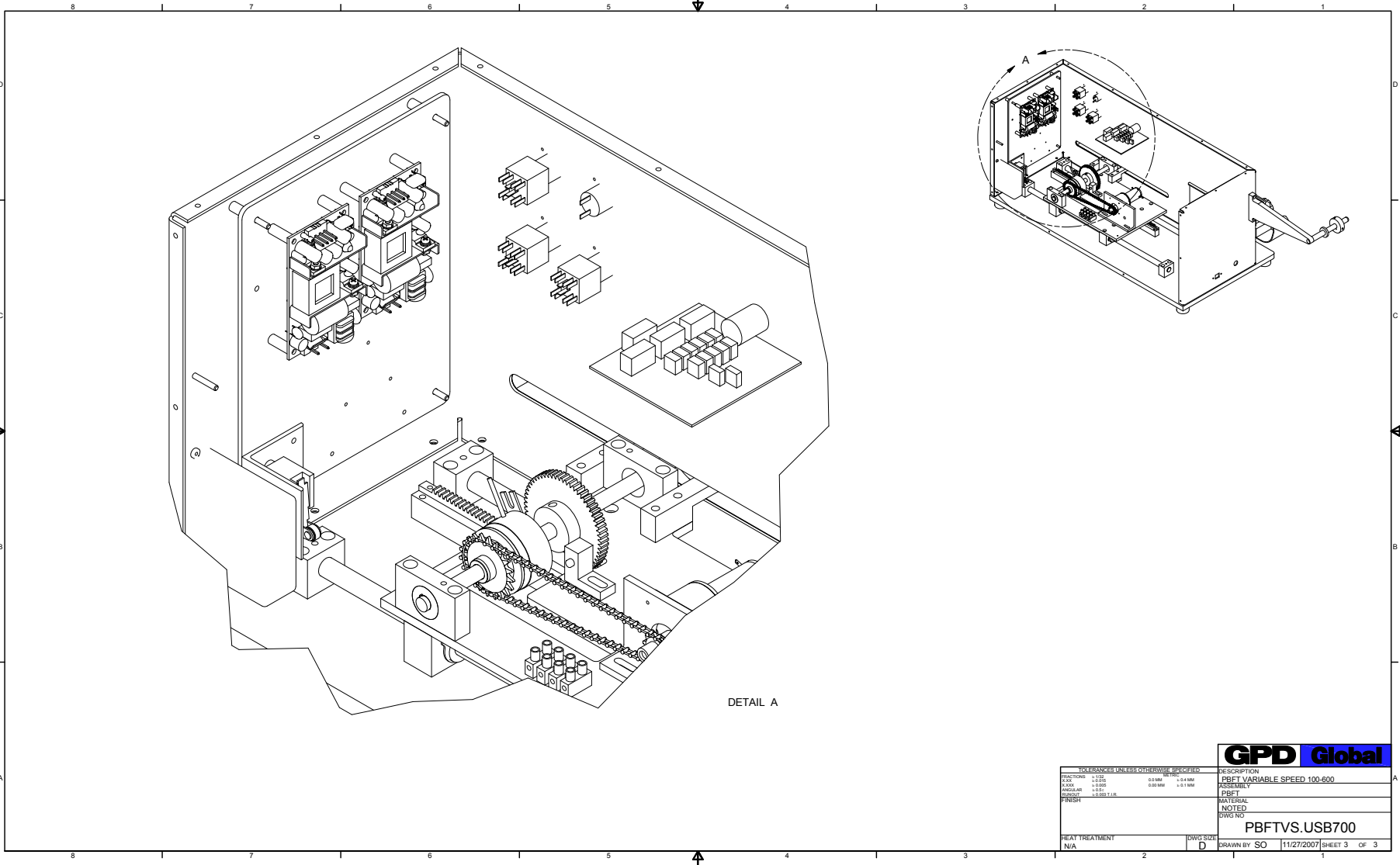

<b>GPD Global</b>		<b>DESCRIPTION</b>	
EXEMPTIONS UNLESS OTHERWISE SPECIFIED		PBFT VARIABLE SPEED 100-600	
FUNCTIONS	± 0.2%	± 0.1MM	± 0.1MM
FORM	± 0.005	± 0.1MM	± 0.1MM
ANGLE	± 0.5°	± 0.1MM	± 0.1MM
FINISH	± 0.001 I.R.		
MATERIAL		NOTED	
DWG NO		PBFTVS.USB700	
HEAT TREATMENT		DWG SIZE	D
N/A		DRAWN BY	SO
		DATE	11/27/2007
		SHEET	3
		OF	3

# System block diagram - 00021-856-008

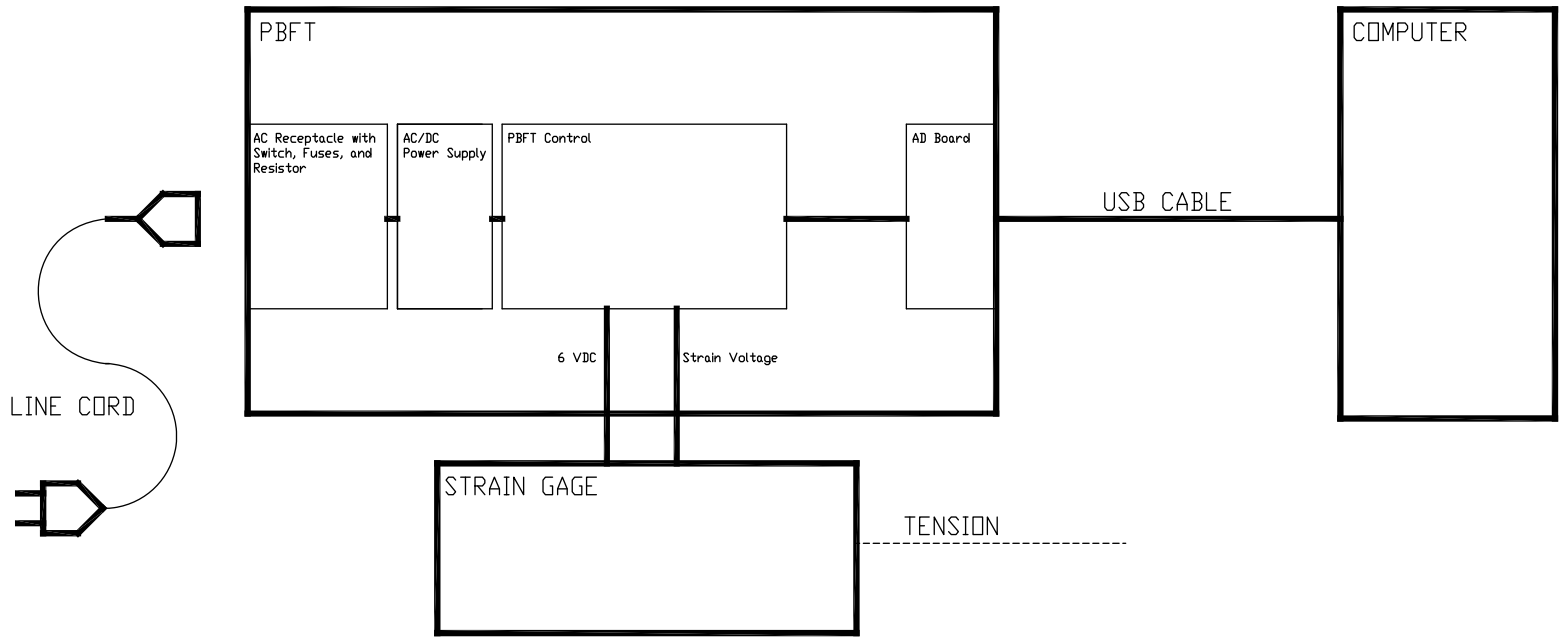

12/9/21

PBFT VS SPC User Guide

106

GPD Global®

Schematics System block diagram - 00021-856-008



<b>DRAWN:</b> SAH	<b>DATE:</b> 03-06-08	<b>THIS DRAWING:</b> PBFT SCHEMATIC	<b>NAME:</b> BLOCK DIAGRAM	<b>DRWG NUMBER:</b> 00021-856-008-00
----------------------	--------------------------	--	-------------------------------	---

# Electrical schematic - 00021-856-002-06

12/9/21

PBFT VS SPC User Guide

107

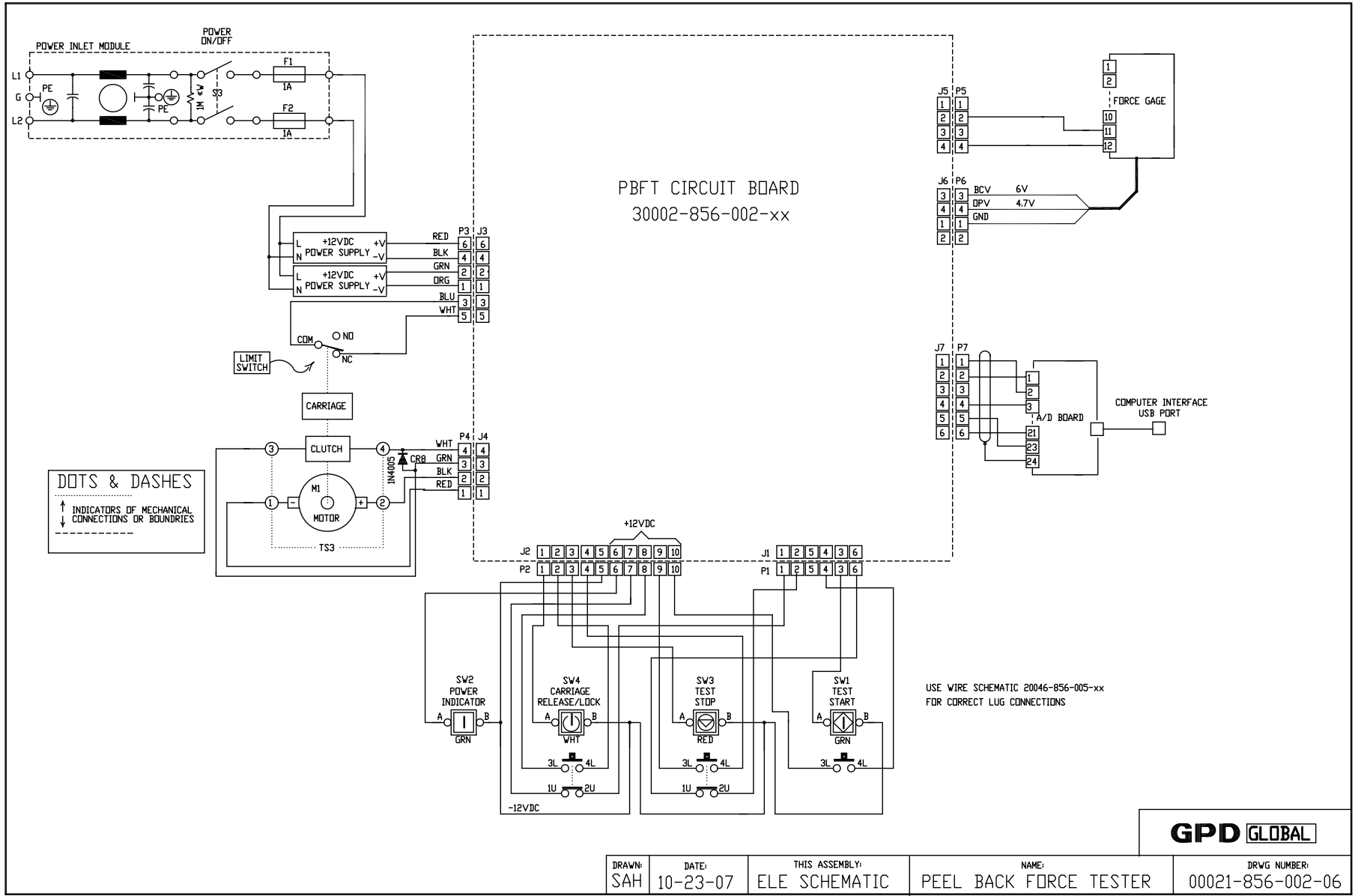

GPD Global®

Schematics Electrical schematic - 00021-856-002-06

# PCB schematic - 30002-856-002-01

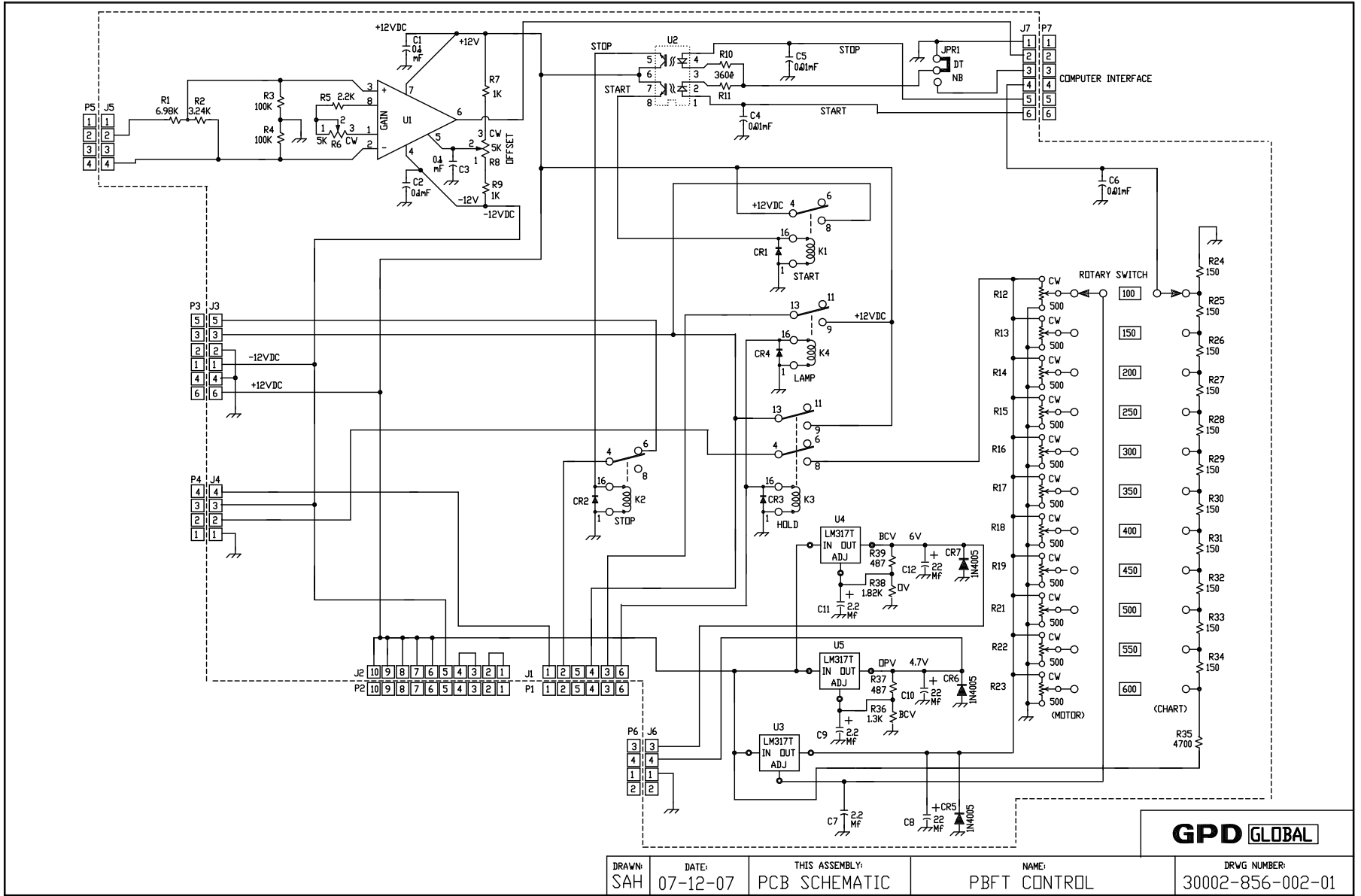

DRAWN: SAH	DATE: 07-12-07	THIS ASSEMBLY: PCB SCHEMATIC	NAME: PBFT CONTROL	DRWG NUMBER: 30002-856-002-01
------------	----------------	------------------------------	--------------------	-------------------------------

